

Window & Door Trim



An unforgettable first impression.

Transform the look of any home with Fypon® window and door trim. Designed to work together, these pieces are quick and easy to install.



Product Shown:

- Board & Batten Shutters
- Classic Crosshead
- Peaked Cap Pediment
- Dentil Moulding
- Flat Trim
- Triangle Louvers
- Straight Rail Kit
- PremiumSelect Fluted Column Wraps

Crossheads29

Pediments46

Pilasters52

Window Trim59

Window Panel62

Dormer Trim System62

Keystones63

Smooth Shutters64

Smooth Shutter Board
Fabrication Panels.....70

Wood-Grained Shutters.....73

Wood-Grained Shutter Board
Fabrication Panels.....88

Shutter Accessories89



Window & Door Trim

How to Use This Section

Where applicable, part numbers are shown for products with attached accessories, or other available unattached accessories are referenced or shown with the product.

How to Order

Door Trim & Entrance Systems

When ordering door trim, first measure the door unit to be trimmed. The unit can be measured with or without brickmould; however, the brickmould is essential when using a storm door. Next, choose the desired pilaster style and size. Finally, choose a pediment or crosshead that is wide enough to span the opening plus the brickmould and pilasters or flat trim. Add desired accessories to complete the look.

Window & Door Trim Accessories

Keystones, dentil trim, trim strip and bottom trim accessories are available attached to standard products as fabricated products. A keystone can also be ordered as an unattached accessory.

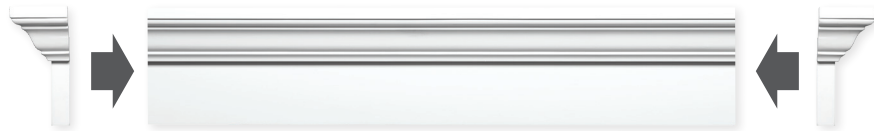

How to Order Trimmable Crosshead

Example

1	Determine height.	6" high
2	Determine breast board width of crosshead.	36" width
3	Select end cap width. End cap widths should coordinate with pilaster or moulding on either side of door / window. If no moulding is used, then any end cap can be selected.	CHC4X6 (Coordinating over 3-1/2" flat trim)
4	Calculate trimmable crosshead; account for end cap. Crosshead breast board width - (end cap back surface x 2) = trimmable crosshead	36" - (2-1/2" x 2) = 31" required*
5	Select trimmable crosshead.	CHT36X6
6	Optional: Select accessory moulding / keystone.	K6M and MLD716-12

*End cap back surface.

Window & Door Trim Applications

Distinction Crosshead with End Caps

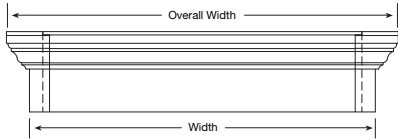

Craftsman Cove Crosshead with End Caps

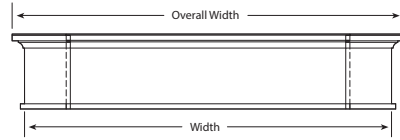

Classic Crosshead without Accessories



Classic Crosshead with Accessories

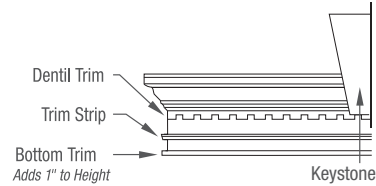

Note: A keystone cannot be used when combining a crosshead with a pediment.

Window Trim Terminology

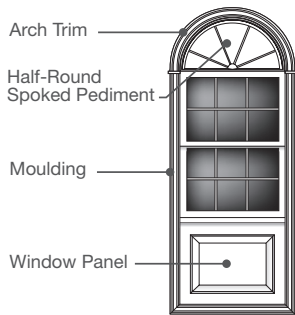

Keystone Options



Crosshead Options for Entry Way

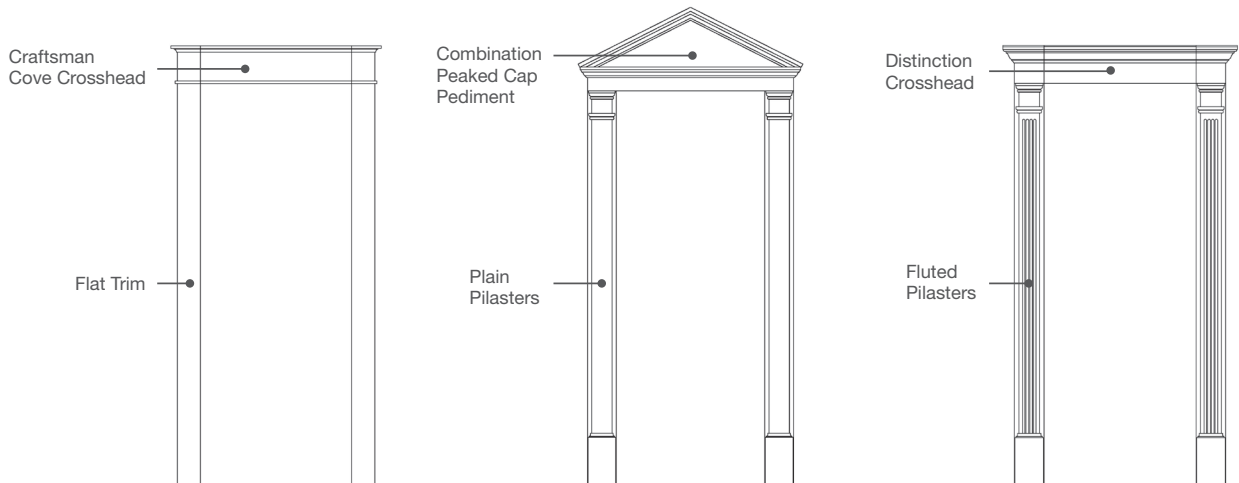

Distinction Crosshead



Ready-to-Install

- Our Distinction crosshead line includes heights measuring 6" and 9". Widths for 6" are 24" – 144", and widths for 9" are 24" – 216", both in 1" increments.
- End cap comes standard with 1-1/2" width and overlaps crosshead.

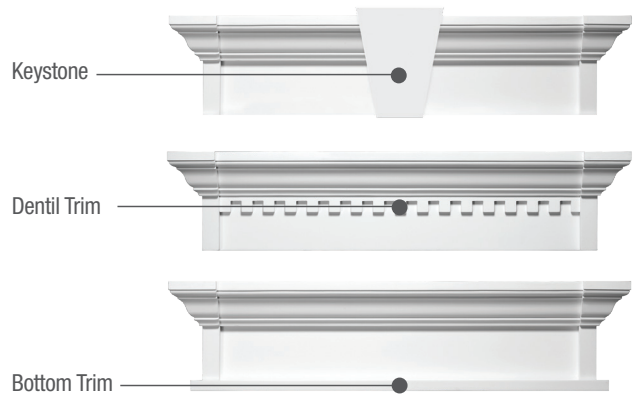

6" & 9" Distinction Crosshead

Ready-to-Install



Part Number Logic:

CH24X6EC

<p>[Profile] CH = Crosshead</p>	<p>[Height] 6 = 6" 7 = 7" (BT option only) 9 = 9" 10 = 10" (BT option only)</p>	<p>[Configuration] BT = Bottom Trim D = Dentil Trim K = Keystone R = Routed</p>
<p>[Breast Board Width] (1" increments) 24 = 24" [Minimum] 144 = 144" [Maximum for 6" high] 216 = 216" [Maximum for 9" high]</p>		

Distinction Crosshead with Coordinating Pilaster Widths

Ready-to-Install



Part Number Logic:

CH51X6EC5

<p>[Profile] CH = Crosshead</p>	<p>[Pilaster Width*] 5 = 5-1/4" 7 = 7" 9 = 9"</p>	<p>[Crosshead Width] (1" increments) 51 = 51" [Minimum] 96 = 96" [Maximum]</p>
	<p>[Crosshead Height] 6 = 6" 9 = 9"</p>	

EC = End Cap

If pilasters are to be included as part of the opening, remember the following:

- 1) Remember to account for lighting, door bells, mailboxes or any other item that could dictate the width of the pilaster.
- 2) Don't forget to take into account brickmould, if applicable.
- 3) Breast board of crosshead should fit over the entire width of the right and left pilasters.

*The last character in the part number coordinates with the pilaster width.

Trimmable

- Distinction trimmable crossheads are available in heights measuring 6" and 9", and widths measuring 36", 48", 144" and 216".
 - 36" and 48" widths allow for ease of handling and quick installation.
 - 144" and 216" widths can be cut to any length, minimizing waste in the field.
- End caps overlap the trimmable crosshead.
- End caps may be routed.

6" & 9" Distinction Crosshead

Trimmable



6" Height		9" Height		Overall Width
CHT36X6		CHT36X9		36"
CHT48X6		CHT48X9		48"
CHT144X6		CHT144X9		144- ³ / ₈ "
CHT216X6		CHT216X9		216- ⁵ / ₈ "

End Caps

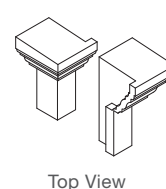
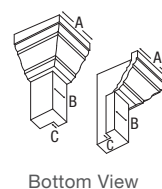



6" Height			9" Height			Breast Board Width (B)	Rabbit Width (C)
Qty 1	Qty 5	Overall Width (A)	Qty 1	Qty 5	Overall Width (A)		
CHC2X6	CHC2X6-5	3- ¹ / ₄ "	CHC2X9	CHC2X9-5	4- ¹ / ₄ "	1- ¹ / ₂ "	1/2"
CHC4X6	CHC4X6-5	5- ¹ / ₄ "	CHC4X9	CHC4X9-5	6- ¹ / ₄ "	3- ¹ / ₂ "	1"
CHC7X6*	CHC7X6-5*	8- ³ / ₄ "	CHC7X9*	CHC7X9-5*	9- ³ / ₄ "	7"	4"
CHC11X6*	CHC11X6-5*	12- ³ / ₄ "	CHC11X9*	CHC11X9-5*	13- ³ / ₄ "	11"	4"

*Trimmable up to 3-¹/₂".
Note: End caps are sold in pairs.



Distinction Accessories

	Accessory	6" Height	9" Height
	Keystone	K6M	K9M
	Dentil	MLD357-8	MLD358-8
	Bottom Trim	MLD716-12	MLD758-12

Craftsman Cove Crosshead



Ready-to-Install

- Our expanded Craftsman Cove crosshead line includes heights measuring 9" and widths measuring 24" – 216", in 1" increments.
- End caps come standard with 3-1/2" width and overlap crosshead.
- End caps may be routed.

9" Craftsman Cove Crosshead

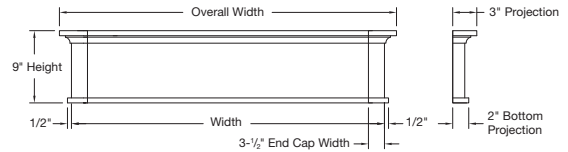

Part Number Logic:

CHCC24X9BTEC__

<p>[Profile] CHCC = Craftsman Cove Crosshead</p>	<p>[Breast Board Width] (1" increments) 24 = 24" [Minimum] 216 = 216" [Maximum]</p>	<p>[Height] 9 = 9"</p>	<p>[Configuration] R = Routed EC = End Cap BT = Bottom Trim</p>	<p>If flat trim is to be included as part of the opening, remember the following:</p> <ol style="list-style-type: none"> 1) Account for lighting, door bells, mailboxes or any other item that could dictate the width of the trim. 2) Don't forget to take into account brickmould, if applicable. 3) Breast board of the crosshead or crosshead end cap should fit over both the left and right trim pieces.
---	--	-----------------------------------	--	---





How to Order

- ① Determine height.
- ② Determine breast board width. When installing over side trim CHCCC6X9BT coordinates best with 5-1/4" pilaster and 5-1/2" wide trim.
- ③ Select end cap width.



Trimable

- Our expanded Craftsman Cove crosshead line includes a 9" height, measuring 36", 48", 144" and 216".
- End caps do not come standard with trimmable product. They must be ordered. 3-1/2" or 5-1/2" end caps are optional; complement standard trim widths.
- End caps overlap crosshead.
- Crosshead and end caps may be routed.

9" Craftsman Cove Crosshead

Trimmable

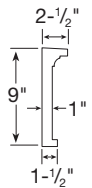
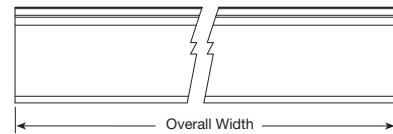

Part Number	Overall Width
CHCCT36X9BT	36"
CHCCT48X9BT	48"
CHCCT144X9BT	144"
CHCCT216X9BT	216"

9" Craftsman Cove End Caps



3-1/2" End Caps



5-1/2" End Caps

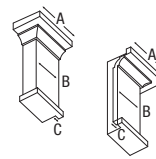

Bottom View

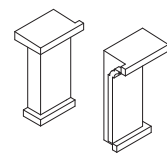

Top View

Part Number (Qty 1)	Part Number (Qty 2)	Overall Width (A)	Width (B)	Rabbit Width (C)
CHCCC4X9BT	CHCCC4X9BT-5*	5"	3-1/2"	1/2"
CHCCC6X9BT	CHCCC6X9BT-5*	7"	5-1/2"	1/2"

*Pack quantity of five pair (10 pieces total).
Note: End cap overlaps the trimmable crosshead.

Craftsman Step Crosshead



6" Craftsman Step Crosshead

Trimable

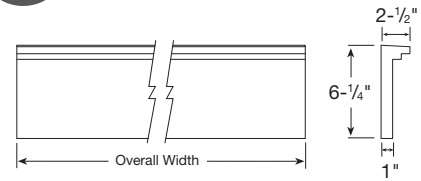

Part Number	Overall Width	Height
CHCST36X6	36"	6-1/4"
CHCST48X6	48"	6-1/4"
CHCST144X6	144- ³ / ₈ "	6-1/4"
CHCST216X6	216- ⁵ / ₈ "	6-1/4"

8" Craftsman Step Crosshead

Trimable

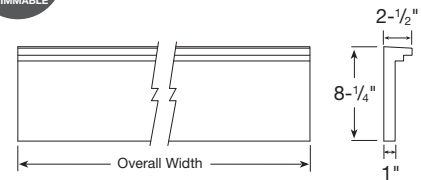
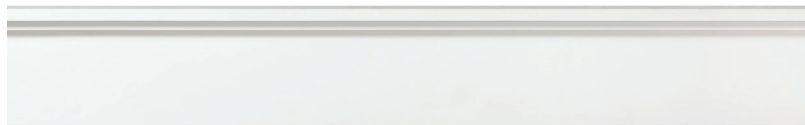

Part Number	Overall Width	Height
CHCST36X8	36"	8-1/4"
CHCST48X8	48"	8-1/4"
CHCST144X8	144- ³ / ₈ "	8-1/4"
CHCST216X8	216- ⁵ / ₈ "	8-1/4"



Note: Craftsman Step crossheads may be routed.

Classic Crosshead



WCH24X6

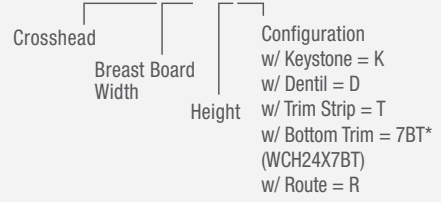

6" Classic Crosshead

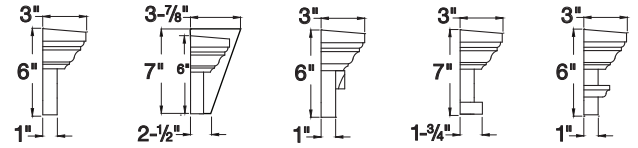
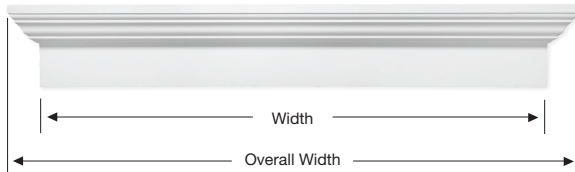

Standard w/ Keystone K6M w/ Dentil Trim w/ Bottom Trim* w/ Trim Strip

Part Number	Width	Overall Width
WCH24X6	24"	27-1/2"
WCH28X6	28"	31-1/2"
WCH30X6	30"	33-1/2"
WCH31X6	31"	34-1/2"
WCH32X6	32"	35-1/2"
WCH33X6	33"	36-1/2"
WCH34X6	34"	37-1/2"
WCH35X6	35"	38-1/2"
WCH36X6	36"	39-1/2"
WCH37X6	37"	40-1/2"
WCH38X6	38"	41-1/2"
WCH40X6	40"	43-1/2"
WCH41X6	41"	44-1/2"
WCH43X6	43"	46-1/2"
WCH44X6	44"	47-1/2"
WCH46X6	46"	49-1/2"
WCH47X6	47"	50-1/2"
WCH48X6	48"	51-1/2"
WCH50X6	50"	53-1/2"
WCH51X6	51"	54-1/2"
WCH52X6	52"	55-1/2"
WCH54X6	54"	57-1/2"
WCH56X6	56"	59-1/2"

Part Number	Width	Overall Width
WCH60X6	60"	63-1/2"
WCH64X6	64"	67-1/2"
WCH66X6	66"	69-1/2"
WCH67X6	67"	70-1/2"
WCH68X6	68"	71-1/2"
WCH72X6	72"	75-1/2"
WCH73X6	73"	76-1/2"
WCH74X6	74"	77-1/2"
WCH76X6	76"	79-1/2"
WCH78X6	78"	81-1/2"
WCH79X6	79"	82-1/2"
WCH80X6	80"	83-1/2"
WCH80.5X6	80-1/2"	84"
WCH84X6	84"	87-1/2"
WCH86X6	86"	89-1/2"
WCH87X6	87"	90-1/2"
WCH96X6	96"	99-1/2"
WCH100X6	100"	103-1/2"
WCH103X6	103"	106-1/2"
WCH104X6	104"	107-1/2"
WCH108X6	108"	111-1/2"
WCH110X6	110"	113-1/2"
WCH144X6	144"	147-1/2"

*Bottom trim adds 1" to overall height.

Part Number Logic:

9" Classic Crosshead

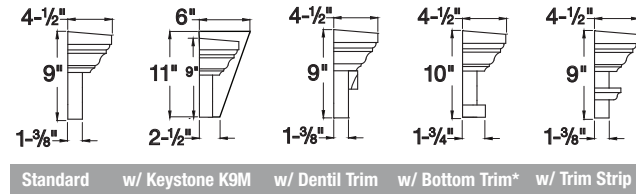
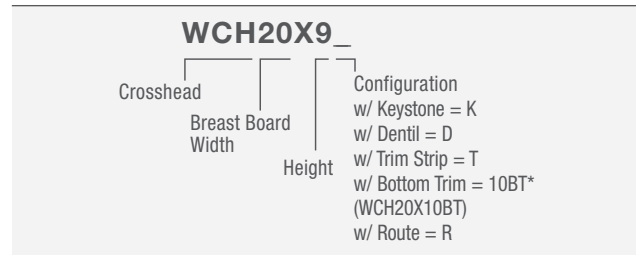

Part Number	Width	Overall Width
WCH20X9	20"	25-1/2"
WCH24X9	24"	29-1/2"
WCH25X9	25"	30-1/2"
WCH26X9	26"	31-1/2"
WCH27X9	27"	32-1/2"
WCH28X9	28"	33-1/2"
WCH29X9	29-5/8"	35-1/8"
WCH30X9	30-1/4"	35-3/4"
WCH32X9	32"	37-1/2"
WCH33X9	33"	38-1/2"
WCH34X9	34"	39-1/2"
WCH35X9	35"	40-1/2"
WCH36X9	36"	41-1/2"
WCH37X9	37"	42-1/2"
WCH38X9	38"	43-1/2"
WCH40X9	40"	45-1/2"
WCH41X9	41"	46-1/2"
WCH42X9	42"	47-1/2"
WCH43X9	43"	48-1/2"
WCH44X9	44"	49-1/2"
WCH45X9	45"	50-1/2"
WCH46X9	46"	51-1/2"
WCH48X9	48"	53-1/2"
WCH49X9	49"	54-1/2"
WCH50X9	50"	55-1/2"
WCH54X9	54"	59-1/2"

Part Number	Width	Overall Width
WCH56X9	56"	61-1/2"
WCH58X9	58"	63-1/2"
WCH60X9	60"	65-1/2"
WCH62X9	62"	67-1/2"
WCH64X9	64"	69-1/2"
WCH65X9	65"	70-1/2"
WCH66X9	66"	71-1/2"
WCH67X9	67"	72-1/2"
WCH68X9	68"	73-1/2"
WCH69X9	69"	74-1/2"
WCH70X9	70"	75-1/2"
WCH72X9	72"	77-1/2"
WCH73X9	73"	78-1/2"
WCH74X9	74"	79-1/2"
WCH75X9	75"	80-1/2"
WCH76X9	76"	81-1/2"
WCH77X9	77"	82-1/2"
WCH78X9	78"	83-1/2"
WCH80X9	80"	85-1/2"
WCH81X9	81"	86-1/2"
WCH82X9	82"	87-1/2"
WCH84X9	84"	89-1/2"
WCH85X9	85"	90-1/2"
WCH86X9	86"	91-1/2"
WCH88X9	88"	93-1/2"
WCH90X9	90"	95-1/2"

*Bottom trim adds 1" to overall height.



9" Classic Crosshead

Part Number	Width	Overall Width
WCH93X9	93"	98-1/2"
WCH96X9	96"	101-1/2"
WCH99X9	99"	104-1/2"
WCH100X9	100"	105-1/2"
WCH101X9	101"	106-1/2"
WCH103X9	103"	108-1/2"
WCH104X9	104"	109-1/2"
WCH108X9	108"	113-1/2"
WCH110X9	110"	115-1/2"
WCH112X9	112"	117-1/2"

Part Number	Width	Overall Width
WCH113X9	113"	118-1/2"
WCH120X9	120"	125-1/2"
WCH124X9	124"	129-1/2"
WCH144X9	144"	149-1/2"
WCH192X9	192"	197-1/2"
WCH196X9	196"	201-1/2"
WCH197X9	197"	202-1/2"
WCH200X9	200"	205-1/2"
WCH204X9	204"	209-1/2"
WCH207X9	207"	212-1/2"





Part Number Logic:

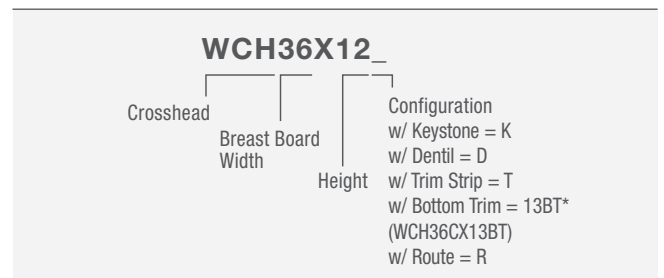

12" Classic Crosshead

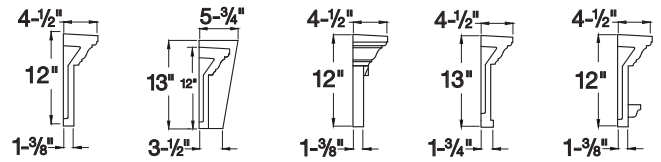

Standard w/ Keystone K12M w/ Dentil Trim w/ Bottom Trim* w/ Trim Strip

Part Number	Width	Overall Width
WCH36X12	36"	41-1/2"
WCH40X12	40"	45-1/2"
WCH44X12	44"	49-1/2"
WCH48X12	48"	53-1/2"
WCH54X12	54"	59-1/2"
WCH56X12	56"	61-1/2"
WCH64X12	64"	69-1/2"
WCH72X12	72"	77-1/2"

Part Number	Width	Overall Width
WCH96X12	96"	101-1/2"
WCH102X12	102"	107-1/2"
WCH104X12	104"	109-1/2"
WCH144X12	144"	149-1/2"
WCH200X12	200"	205-1/2"
WCH203X12	203"	208-1/2"
WCH213X12	213"	218-1/2"

*Bottom trim adds 1" to overall height.

6" Crosshead Arch

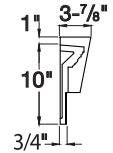
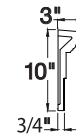
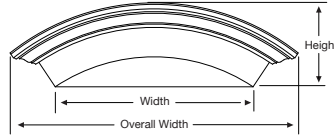

Standard

w/ Keystone K6M

Part Number	Part Number w/ Keystone	Width	Overall Width	Height
WCH6ARS34X10	WCH6ARS34X10K	34"	42-7/8"	10"

Part Number Logic:

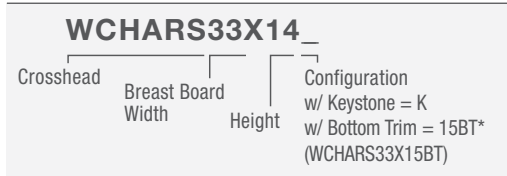

9" Crosshead Arch

Solid

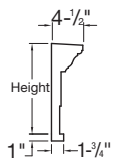
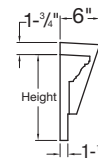
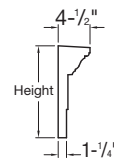
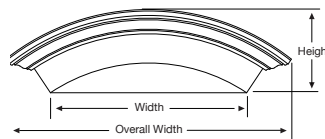

Standard

w/ Keystone K9M

w/ Bottom Trim*

Part Number	Width	Overall Width	Height
WCHARS33X14	33"	48-1/8"	14"
WCHARS36X13	36"	49-1/4"	13"
WCHARS43X13	43"	55-1/4"	13"
WCHARS54X16	54"	68-1/8"	16"
WCHARS64X14	64"	75-1/2"	14"
WCHARS68X12	68"	77-1/4"	12"
WCHARS68X16	68"	80-7/8"	16"
WCHARS72X13	72"	82-1/8"	13"
WCHARS75X13	75"	84-7/8"	13-3/8"
WCHARS80X15	80"	91-1/4"	15"
WCHARS84X16	84"	95-3/4"	16"
WCHARS89X13	89"	98-3/8"	13"
WCHARS97X17	97"	108-3/4"	17"
WCHARS101X13	101"	110"	13"
WCHARS108X19	108"	119-7/8"	19-1/4"

*Bottom trim adds 1" to overall height.

Part Number Logic:

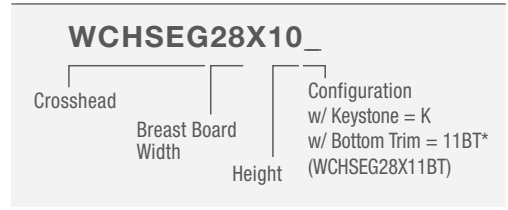

10" Eyebrow Crosshead

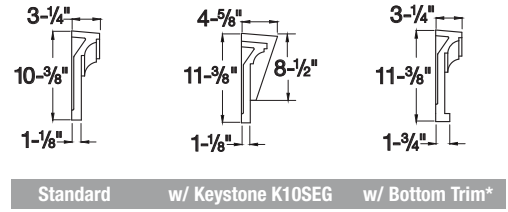
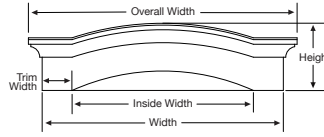

Part Number	Width	Inside Width	Overall Width
WCHSEG28X10	37-1/4"	28"	41-1/2"
WCHSEG30X10	39-1/8"	29-7/8"	43-3/8"
WCHSEG34X10	44"	34"	48-1/4"
WCHSEG36X10	45"	36"	49-1/4"
WCHSEG43X10	48"	43"	52-1/4"
WCHSEG44X10	49"	44"	53-1/4"
WCHSEG64X10	73-1/4"	64"	77-1/2"
WCHSEG72X10	81"	72"	85-1/4"

Large Door Crosshead

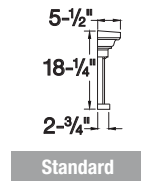
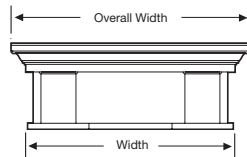

Part Number	Width	Overall Width	Pediment	Pilaster
LDCH58X18	58"	67-1/2"	AP667, PCP667, SP667	All 11" Pilasters
LDCH62X18	62"	71-1/2"	AP667, PCP667, SP667	
LDCH87X18	87"	96-1/2"	—	
LDCH90X18	90-1/2"	100"	—	
LDCH94X18	94-1/2"	104"	—	

Half-Round Spoked Pediment

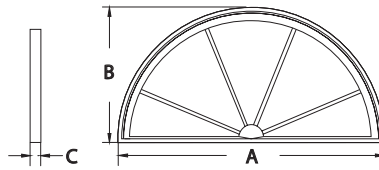

Part Number	Width (A)	Height (B)	Projection (C)	Flat Trim	Decorative Trim
HRSP36X18	36"	18"	1-3/4"	AR36X4F AR36X6F	AR36X4M, AR36X6M AR36X10MC
HRSP48X24	48"	24"	1-3/4"	AR48X4F AR48X6F	AR48X4M, AR48X6M
HRSP72X36	72"	36"	1-3/4"	AR72X4F	AR72X6M

Segment Sunburst



Part Number	Width (A)	Height (B)	Projection (C)
SWDH36X9	36"	9"	1-3/4"
SWDH48X13	48"	13"	1-3/4"
SWDH68X14	67-5/8"	14"	1-3/4"
SWDH72X14	72"	14"	1-3/4"
SWDH76X15	76"	15"	1-3/4"
SWDH80X15	79-1/2"	15"	1-3/4"

Elliptical Sunburst

with Decorative Trim

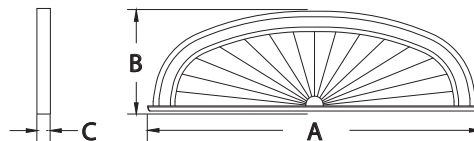

Part Number	Width (A)	Height (B)	Projection (C)
ESWDH76X23	76-7/8"	23"	3-1/2"

Half-Round Sunburst

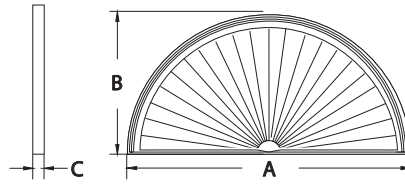

Keystone
KWM180M Page 63

Part Number	Width (A)	Height (B)	Projection (C)	Flat Trim	Decorative Trim
SWDH24X12	24"	12"	1-3/4"	AR24X4F	—
SWDH28X14	28"	14"	1-3/4"	—	—
SWDH30X15	30"	15"	1-3/4"	—	—
SWDH32X16	32"	16"	1-3/4"	—	—
SWDH33X17	33-5/8"	16-3/4"	1-3/4"	—	—
SWDH36X18	36"	18"	1-3/4"	AR36X4F AR36X6F	AR36X4M, AR36X6M AR36X10MC
SWDH37X19	37-5/8"	18-3/4"	1-3/4"	AR37X4F	—
SWDH40X20	40"	20"	1-3/4"	—	AR40X6M DVP40
SWDH42X21	42"	21"	1-3/4"	—	—
SWDH44X22	44"	22"	1-3/4"	—	—
SWDH48X24	48"	24"	1-3/4"	AR48X4F AR48X6F	AR48X4M, AR48X6M
SWDH56X28	56"	28"	1-3/4"	—	—
SWDH60X30	60"	30"	1-3/4"	—	AR60X6M
SWDH64X32	64"	32"	1-3/4"	—	AR64X10MC
SWDH68X34	68"	34"	1-3/4"	—	—
SWDH72X36	72"	36"	1-3/4"	AR72X4F	AR72X6M
SWDH76X38	76"	38"	1-3/4"	—	—
SWDH100X50	100"	50"	1-3/4"	—	—

Half-Round Sunburst

with Flat Trim & Keystone

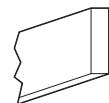
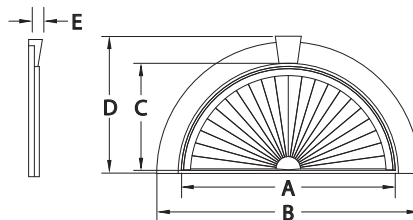

Flat Trim
FLT152

Part Number	Width (A)	Overall Width (B)	Height (C)	Overall Height (D)	Projection (E)
SWDH36X18-4FK	36"	43"	18"	22-1/2"	2-1/4"

Sunburst Pediment

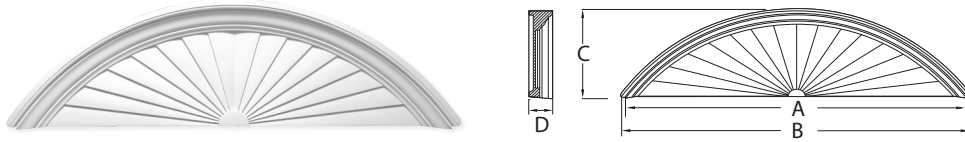

Part Number	Width (A)	Overall Width (B)	Height (C)	Projection (D)	Crosshead
SP56	55-1/4"	57"	16-3/4"	4-1/2"	WCH50X9
SP667	66-3/4"	69-1/4"	20-3/8"	5-1/2"	LDCH58X18 LDCH62X18
SP86	85-5/8"	87-1/4"	22-1/2"	4-1/2"	WCH81X9
SP91	90-1/2"	92-1/2"	26"	4-1/2"	WCH86X9

Combination Sunburst Pediment

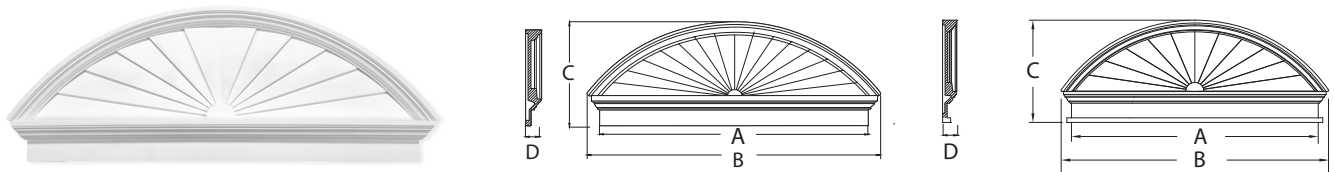

Part Number	Width (A)	Overall Width (B)	Height (C)	Projection (D)	Breast Board Thickness	Part Number w/ Bottom Trim*
CSP54	54"	58-1/2"	21-3/8"	3-1/8"	1"	CSP54BT
CSP75	75"	79-5/8"	23-3/4"	3-1/8"	1"	CSP75BT
CSP80	80"	84-5/8"	25-1/2"	3-1/8"	1"	CSP80BT
CSP85	85"	89-1/2"	26-3/8"	3-1/8"	1"	CSP85BT

Combination Segment Arch Pediment

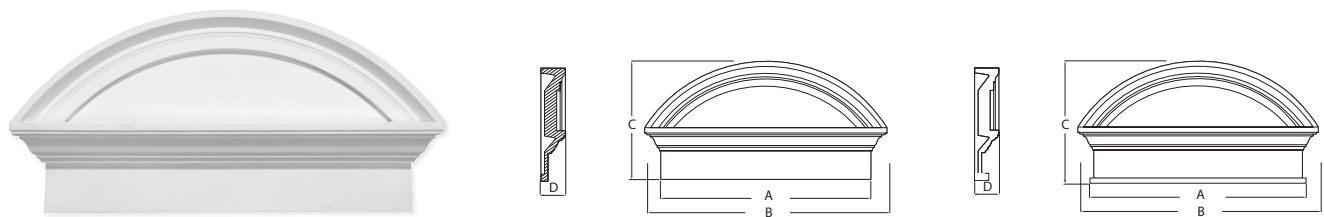

Part Number	Width (A)	Overall Width (B)	Height (C)	Projection (D)	Part Number w/ Bottom Trim*
CSAP36	36"	41-1/2"	20"	4-1/2"	CSAP36BT
CSAP48	48"	53-1/2"	22-1/2"	4-1/2"	CSAP48BT
CSAP65	65"	70-1/2"	28-3/8"	4-1/2"	CSAP65BT
CSAP84	84"	89-1/2"	28"	4-1/2"	CSAP84BT

Peaked Cap Pediment

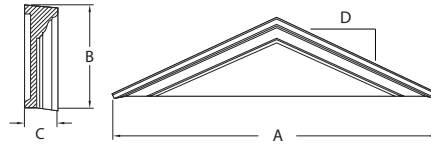

Part Number	Overall Width (A)	Overall Height (B)	Projection (C)	Pitch (D)	Crosshead
PCP56	56-1/2"	13-5/8"	4-1/2"	5-1/2 / 12	WCH50X9
PCP667	68-3/4"	23-5/8"	5-1/2"	8 / 12	LDCH58X18 LDCH62X18

Combination Peaked Cap Pediment

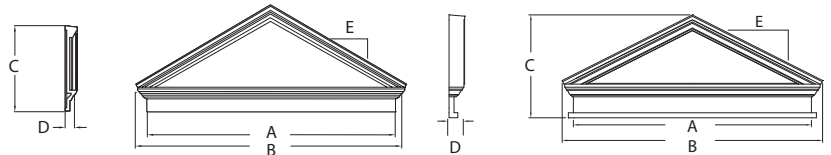

Part Number	Width (A)	Overall Width (B)	Overall Height (C)	Projection (D)	Pitch (E)	Breast Board Thickness	Part Number w/ Bottom Trim*
CPCP48	47-1/2"	52"	19-1/2"	3-1/8"	6 / 12	1"	CPCP48BT
CPCP50	50"	54-1/2"	20-1/4"	3-1/8"	6 / 12	1"	CPCP50BT
CPCP54	54"	58-1/4"	21"	3-1/8"	6 / 12	1"	CPCP54BT
CPCP58	58"	62-3/8"	22"	3-1/8"	6 / 12	1"	CPCP58BT
CPCP67	67-1/2"	72"	24-1/2"	3-1/8"	6 / 12	1"	CPCP67BT
CPCP75	75"	79-1/2"	26-1/4"	3-1/8"	6 / 12	1"	CPCP75BT
CPCP80	80"	84-1/2"	27-5/8"	3-1/8"	6 / 12	1"	CPCP80BT
CPCP85	85"	89-1/2"	28-3/4"	3-1/8"	6 / 12	1"	CPCP85BT

Combination Peaked Cap Pediment

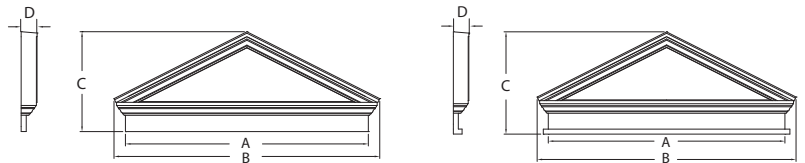

Part Number	Width (A)	Overall Width (B)	Height (C)	Projection (D)	Part Number w/ Bottom Trim*
CCP37	37-5/8"	41-3/4"	20-1/2"	4-1/2"	CCP37BT

*Bottom trim adds 1" to overall height.

Acorn Pediment



Note: Acorn ships unattached in carton.

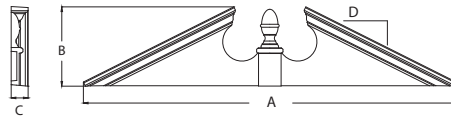

Part Number	Overall Width (A)	Overall Height (B)	Projection (C)	Pitch (D)	Crosshead
AP56	57"	16-5/8"	4-1/2"	6-1/2 / 12	WCH50X9
AP61	62"	17"	4-1/2"	7 / 12	WCH54X9 WCH56X9
AP667	68-7/8"	23-1/4"	5-1/2"	12 / 12	LDCH58X18 LDCH62X18
AP86	87-1/4"	23-1/8"	4-1/2"	7 / 12	WCH81X9
AP91	92-1/8"	24-11/16"	4-1/2"	6 / 12	WCH86X9
AP98	99-1/8"	24-9/16"	4-1/2"	6 / 12	WCH90X9 WCH93X9

Acorn Pediment

Adjustable



Note: Ships in 4 pieces.

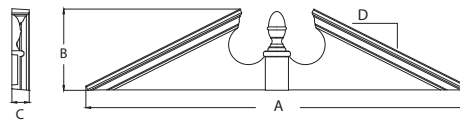

Part Number	Overall Width (A)	Overall Height (B)	Projection (C)	Pitch (D)	Crosshead
AP115	105"-115"	25-5/8"	4-1/2"	6 / 12	9" WCH from 100"-110"

Combination Acorn Pediment



Note: Acorn ships unattached in carton.

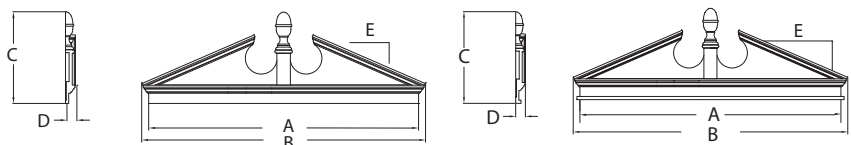

Part Number	Width (A)	Overall Width (B)	Overall Height (C)	Projection (D)	Pitch (E)	Part Number w/ Bottom Trim*
CAP47E**	47"	50-1/8"	13-5/8"	2-1/8"	5 / 12	—
CAP50	50"	54-1/2"	21-1/8"	3-1/8"	6 / 12	CAP50BT
CAP54	54"	58-1/2"	21-3/8"	3-1/8"	6 / 12	CAP54BT
CAP58	58"	62-1/2"	21-3/4"	3-1/8"	6 / 12	CAP58BT
CAP67	67-1/2"	72"	24-1/8"	3"	6 / 12	CAP67BT
CAP75	75"	79-1/2"	25-1/8"	3-1/8"	6 / 12	CAP75BT
CAP80	80"	84-7/16"	25-3/8"	3-1/8"	5-1/2 / 12	CAP80BT
CAP85	85"	89-3/8"	28-3/4"	3-1/8"	5 / 12	CAP85BT

*Bottom trim adds 1" to overall height.

**Does not have breast board. Accessories cannot be added.

Combination Rams Head Pediment



Note: Urn ships unattached in carton.

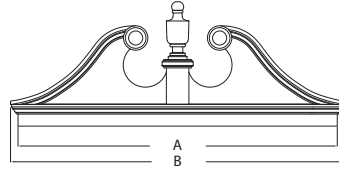

Part Number	Width (A)	Overall Width (B)	Overall Height (C)	Projection (D)	Breast Board Thickness	Part Number w/ Bottom Trim*
CRHP54	54"	58"	23-1/2"	3-1/8"	1"	CRHP54BT
CRHP67	67-1/2"	71-1/2"	27"	3-1/8"	1"	CRHP67BT
CRHP75	75"	79"	29-1/8"	3-1/8"	1"	CRHP75BT
CRHP80	80"	84"	35-3/4"	3-1/8"	1"	CRHP80BT
CRHP85	85"	89"	33-5/8"	3-1/8"	1"	CRHP85BT

Deluxe Victorian Pediment

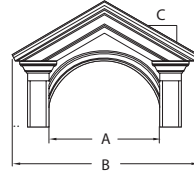

Trim width is 8".

Part Number	Inside Width (A)	Inside Height	Overall Width (B)	Radius	Pitch (C)	Accessories
DVP40	40"	24-1/2"	67-1/4"	20"	7 / 12	PIL8X90P, PIL8X108P, SWDH40X20

7" Panel Arch

with Sunburst & Keystone

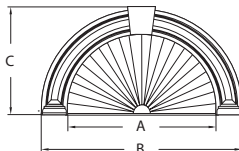

Part Number	Sunburst Width (A)	Overall Width (B)	Height (C)	Radius	Keystone Projection (D)	Pilaster
AR40X54PSK	40"	54"	29"	20"	2-5/8"	PIL7X90DP

Note: PIL7X90DP matches this arch profile only.

10" Decorative Arch

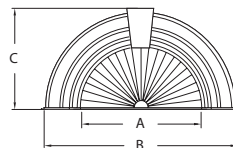

Part Number	Sunburst Width (A)	Overall Width (B)	Height (C)	Radius	Keystone Projection (D)	Pilaster
AR36X10SK	36"	56"	30-1/8"	2-1/8"	4"	PIL10X96A, PIL10X192A

Note: This arch matches PIL10X96A and PIL10X192A only.

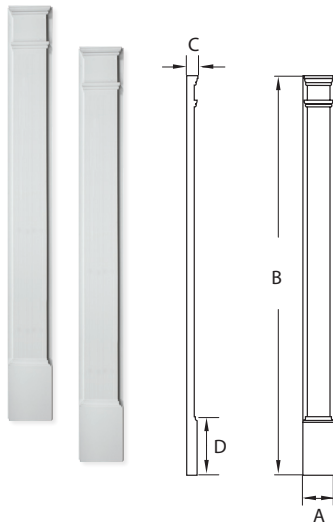

Plain Pilaster

Molded with Plinth

Part Number	Width (A)	Height (B)	Projection (C)	Plinth Block Height (D)
PIL5X90P	5-1/4"	90"	1-5/8"	10-1/8"
PIL6X90P	6"	90"	2-1/2"	13-1/4"
PIL7X90P	7"	90"	2-1/2"	13-1/4"
PIL8X90P	8"	90"	2-1/2"	13-1/4"
PIL9X90P	9"	90"	3"	14-1/2"
PIL11X90P	11"	90"	3-1/2"	13-1/4"

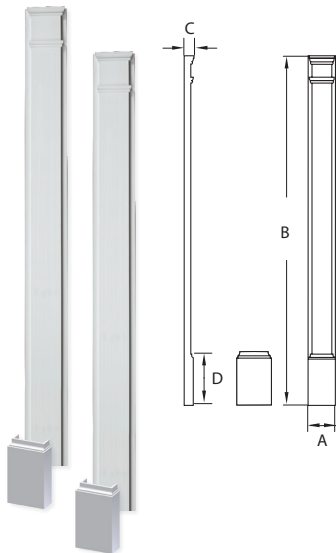

Plain Pilaster

Two-Piece Adjustable

Part Number	Width (A)	Height (B)	Projection (C)	Plinth Block Height (D)
PIL5X108P	5-1/4"	108"	1-5/8"	10"
PIL6X120P	6"	120"	2-1/2"	13-1/4"
PIL7X108P	7"	108"	2-1/2"	13"
PIL7X120P	7"	120"	2-1/2"	13"
PIL8X108P	8"	108"	2-5/8"	13"
PIL9X108P	9"	108"	3"	14-1/2"
PIL9X120P	9"	120"	3"	14-1/2"
PIL10X120P	10"	120"	3-1/4"	14-1/2"
PIL11X96P	11"	96"	3-1/2"	14-1/2"
PIL11X108P	11"	108"	3-1/2"	14-1/2"
PIL11X120P	11"	120"	3-1/2"	14-1/2"



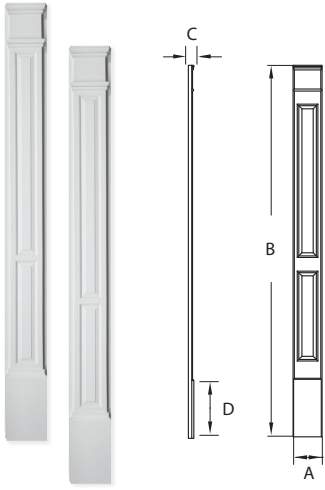

Double Panel Pilaster

Molded with Plinth

Part Number	Width (A)	Height (B)	Projection (C)	Plinth Block Height (D)
PIL5X90DP	5-1/4"	90"	1-5/8"	10-1/8"
PIL7X90DP	7"	90"	2-1/2"	13-1/4"
PIL9X90DP	9"	90"	3"	14-1/2"
PIL9X100DP	9"	100"	3"	14-1/2"
PIL11X90DP	11"	90"	3-1/2"	14-1/2"
PIL11X108DP	11"	108"	3-1/2"	14-1/2"

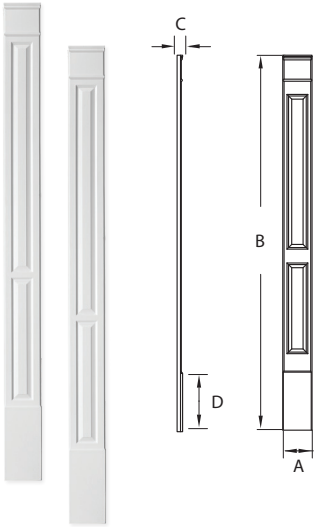

Double Panel Narrow Pilaster

Molded with Plinth

Part Number	Width (A)	Height (B)	Projection (C)	Plinth Block Height (D)
PIL7X90DPE	7"	90"	1-1/4"	14-1/4"

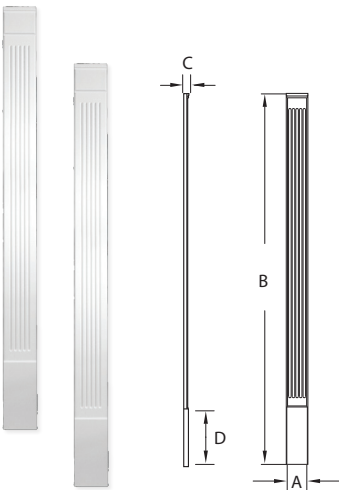

Fluted Narrow Pilaster

Molded with Plinth

Part Number	Width (A)	Height (B)	Projection (C)	Plinth Block Height (D)
PIL5X90E	5-1/4"	90"	1-1/4"	14-1/4"
PIL7X90E	7"	90"	1-1/4"	14-1/4"
PIL9X90E	9"	90"	1-1/4"	14-1/4"

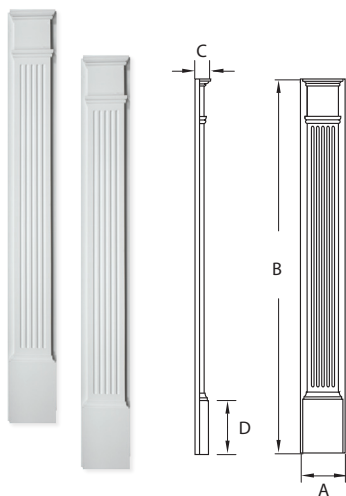

Fluted Pilaster

Molded with Plinth

Part Number	Width (A)	Height (B)	Projection (C)	Plinth Block Height (D)
PIL4X83	4-1/2"	82-3/4"	1-5/8"	7-3/4"
PIL4X86	4-1/2"	86"	1-5/8"	11"
PIL4X90	4-1/2"	90"	1-5/8"	10"
PIL5X82	5-1/4"	82"	1-3/4"	8"
PIL5X90	5-1/4"	90"	1-3/4"	10-1/8"
PIL6X90	6-1/4"	90"	2-1/2"	13-1/4"
PIL7X90	7"	90"	2-1/2"	13-1/4"
PIL9X90	9"	90"	3"	14-1/2"
PIL11X90	11"	90"	3-1/2"	14-1/2"

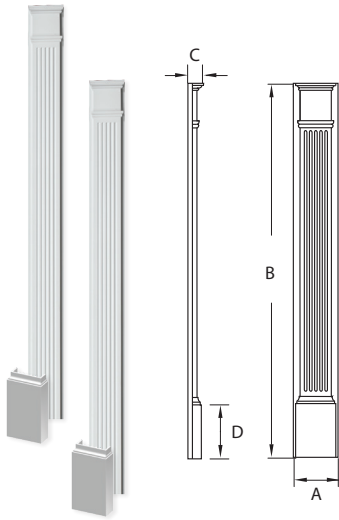

Fluted Pilaster

Two-Piece Adjustable

Part Number	Width (A)	Height (B)	Projection (C)	Plinth Block Height (D)
PIL3X108	3-1/2"	108"	1-5/8"	10"
PIL4X108	4-1/2"	108"	1-5/8"	10"
PIL5X108	5-1/4"	108"	1-5/8"	10"
PIL6X108	6-1/4"	108"	2-1/2"	13-1/4"
PIL6X144	6-1/4"	144"	2-1/2"	13-1/4"
PIL7X102	7"	102"	2-1/2"	13-1/4"
PIL7X108	7"	108"	2-1/2"	13"
PIL7X144	7"	144"	2-1/2"	13"
PIL8X90	8"	90"	2-1/2"	13"
PIL8X108	8"	108"	2-1/2"	13"
PIL8X144	8"	144"	2-1/2"	13"
PIL9X102	9"	102"	3"	14-1/2"
PIL9X108	9"	108"	3"	14-1/2"
PIL9X144	9"	144"	3"	14-1/2"
PIL11X108	11"	108"	3-1/2"	14-1/2"
PIL11X120	11"	120"	3-1/2"	14-1/2"
PIL11X144	11"	144"	3-1/2"	14-1/2"

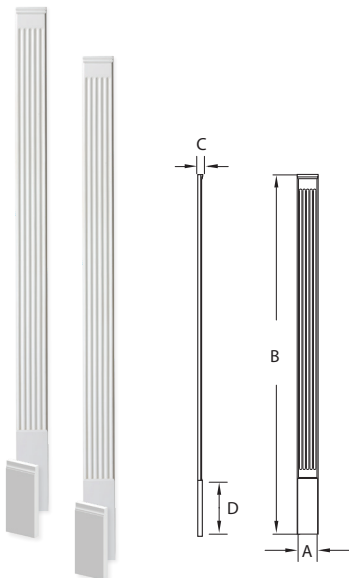

Fluted Narrow Pilaster

Two-Piece Adjustable

Part Number	Width (A)	Height (B)	Projection (C)	Plinth Block Height (D)
PIL5X120E	5-1/4"	120"	1-1/4"	14-1/4"



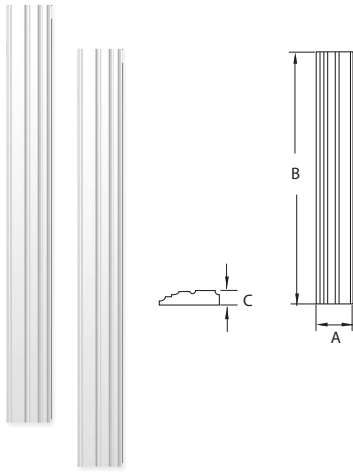

Arch Profile Pilaster

Matches 10M Decorative Arches

Part Number	Width (A)	Height (B)	Projection (C)
PIL10X192A	10"	192"	2- ³ / ₈ "

Note: See page 60 for matching arches.

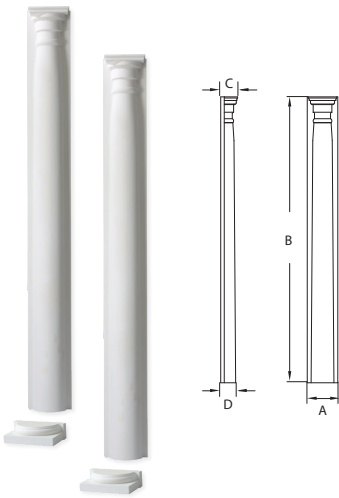

Half-Round Pilaster

Adjustable Column

Part Number	Width (A)	Shaft Height* (B)	Top Projection (C)	Bottom Projection (D)
PIL10X96HC	10"	93- ⁵ / ₈ "	4- ⁷ / ₈ "	5- ¹ / ₂ "

Fluted Panel Trim

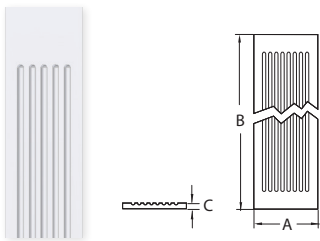

Part Number	Width (A)	Height (B)	Projection (C)
FP12X96	12"	96"	1- ¹ / ₂ "

*Overall height is adjustable from 80" – 96". Shaft sits on top of plinth, which is 3" in height.
Note: Pilasters are sold as a set and may be routed for J-Channel.



Half-Round Arch Trim

4F Flat

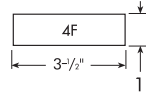
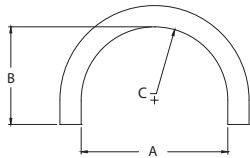

Accessories



Keystone
K4TF



Keystone
KP4TF



Flat Trim
FLT152



Plinth Block
PB4X4

Part Number	Inside Width (A)	Inside Height (B)	Radius (C)
AR24X4F	24-1/8"	16-1/8"	12-1/8"
AR36X4F	36"	22"	18"
AR37X4F	37-5/8"	22-3/4"	18-3/4"
AR48X4F	48"	28"	24"
AR72X4F	72"	40"	36"

Note: This part uses keystones K4TF and KP4TF only.

Half-Round Arch Trim

4M Decorative

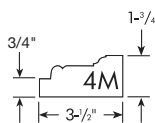
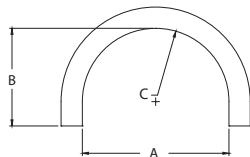

Accessories



Keystone
K4TM



Keystone
KP4TM



Moulding
MLD215

Part Number	Inside Width (A)	Inside Height (B)	Radius (C)
AR36X4M	36"	22"	18"
AR48X4M	48"	28"	24"

Note: This part uses keystones K4TM and KP4TM only.

Half-Round Arch Trim

6F Flat

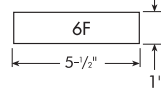
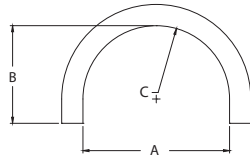

Accessories



Keystone
K6TF



Keystone
KP6TF



Flat Trim
FLT159



Plinth Block
PB6X6

Part Number	Inside Width (A)	Inside Height (B)	Radius (C)
AR36X6F	36"	22"	18"
AR48X6F	48"	28"	24"

Note: This part uses keystones K6TF and KP6TF only.

Half-Round Arch Trim

6M Decorative

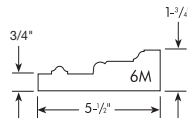
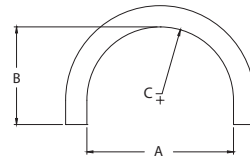

Accessories



Keystone
K6TM



Keystone
KP6TM



Moulding
MLD220

Part Number	Inside Width (A)	Inside Height (B)	Radius (C)
AR36X6M	36"	21"	18-1/32"
AR40X6M	40"	24"	20"
AR48X6M	48"	28"	24"
AR60X6M	60"	34"	30"
AR72X6M	72"	40"	36"

Note: This part uses keystones K6TM and KP6TM only.

Half-Round Arch Trim

10M Decorative

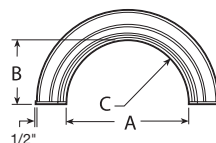

Accessories



Keystone
K10TM



Pilaster
PIL10X96A
PIL10X192A

Part Number	Inside Width (A)	Inside Height (B)	Radius (C)
AR36X10MC	36"	18-3/4"	18"
AR64X10MC*	64"	32-3/4"	32"

*Part ships in two pieces and will need to be trimmed in field to fit.

Half-Round Arch with Flankers

10M Decorative

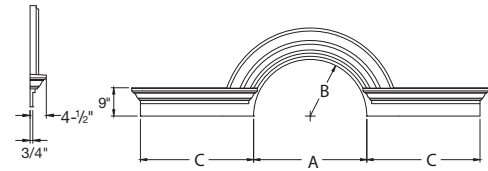

Part Number	Inside Width (A)	Inside Height / Radius (B)	Flanker Width (C)	Overall Width (D)	Accessories
AR36X10MFL108	36"	18"	36"	108"	K10TM SWDH36X18

Circle Trim

4F Flat

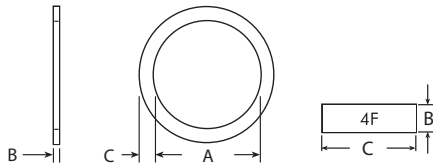

Part Number	Inside Width (A)	Projection (B)	Trim Width (C)
CIR24X4F	24-1/4"	1"	3-1/2"
CIR36X4F	36-1/8"	1"	3-1/2"

Oval Trim

4F Flat

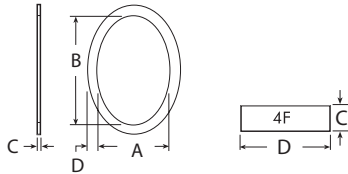

Part Number	Inside Width (A)	Inside Height (B)	Projection (C)	Trim Width (D)
OV24X36X4F	24-1/8"	36-1/8"	1"	3-1/2"

Oval Trim

4M Decorative

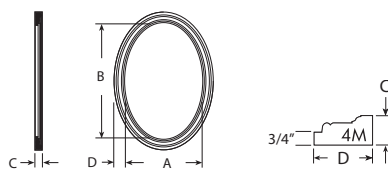

Part Number	Inside Width (A)	Inside Height (B)	Projection (C)	Trim Width (D)
OV24X36X4M	24-1/8"	36-1/8"	1-3/4"	3-1/2"

Window Panel

Raised Panel

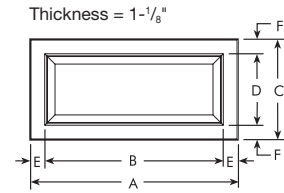

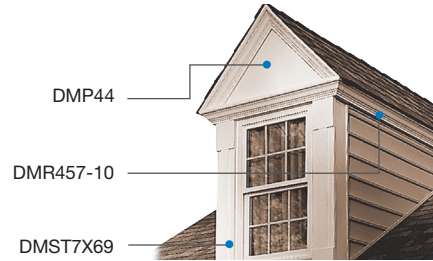

Part Number	Overall Width (A)	Panel Width (B)	Overall Height (C)	Panel Height (D)	Border Width (E)	Border Height (F)
WDP36X18	36"	28"	18"	10"	4"	4"

Dormer Trim System



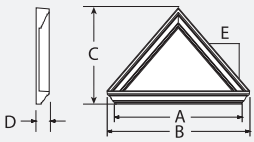

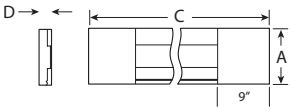
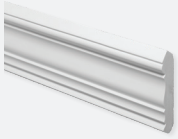
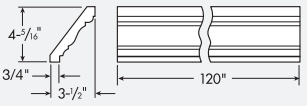







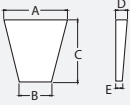

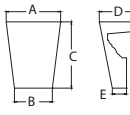

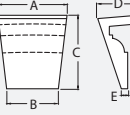

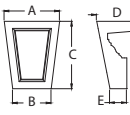
Dormer Trim System

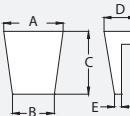
	Part Number	Width (A)	Overall Width (B)	Overall Height (C)	Projection (D)	Pitch (E)	
	DMP44 Pediment	43-3/4"	49-1/4"	33-1/4"	4-1/2"	14 / 12	
	DMST7X69 Side Trim Set	6-3/4"	—	68-5/8"	1-1/2"	—	
	DMR457-10 Return	—	—	—	—	—	

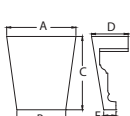

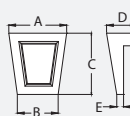
Keystones

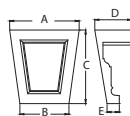
for Trim Profiles

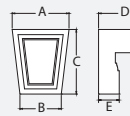
	Part Number	Top Width (A)	Bottom Width (B)	Height (C)	Top Projection (D)	Bottom Projection (E)	Arches & Trim	
	K6*	4-3/4"	2-3/4"	6-1/2"	2-1/4"	1-5/8"	—	
	K8*	9-3/4"	5-3/4"	7-3/4"	2-1/4"	1-1/4"	—	
	K6M	5-3/4"	4"	7"	3-7/8"	1-1/2"	6" WCH, 6" WCH w/ BT 6" CH, 6" CH w/ BT	
	K9M	8"	6"	11"	6-1/8"	1-1/8"	9" WCH, 9" WCH w/ BT 9" CH, 9" CH w/ BT	
	K12M	8-1/2"	6"	13"	5-3/4"	2-1/8"	12" WCH	
	K10SEG	8"	6"	8-1/2"	4-5/8"	3/4"	10" WCHSEG	
	KP6M	5-3/4"	4"	7"	4-1/8"	1-3/4"	6" WCH, 6" WCH w/ BT 6" CH, 6" CH w/ BT	
	KP9M	8"	6"	11"	6-1/4"	1-5/8"	9" WCH, 9" WCH w/ BT 9" CH, 9" CH w/ BT	
	K4TF	4-1/4"	3"	4-1/2"	2-1/4"	1/2"	4F Arches FLT152	
	K6TF	6"	4"	7"	2-3/8"	5/8"	6F Arches FLT159	
	K8TF	7"	5"	8-7/8"	2-1/2"	3/4"	FLT162	
	K4TM	4-1/4"	3"	4-1/2"	2-1/4"	3/4"	4M Arches MLD215	
	K6TM	6"	4"	7"	2-3/8"	7/8"	6M Arches MLD220 DWH221	
	K10TM	8"	5-1/2"	11-1/2"	4"	1-3/4"	10M Arch Trim PIL10X96A PIL10X192A	
	KP4TF	4-1/4"	3"	4-1/2"	2-1/4"	1/2"	4F Arches FLT152	
	KP6TF	6"	4"	7"	2-3/8"	5/8"	6F Arches FLT159	
	KP4TM	4-1/4"	3"	4-1/2"	2-3/4"	3/4"	4M Arch Trim MLD215	
	KP6TM	6"	4"	7"	2-1/2"	7/8"	6M Arch Trim MLD220 DWH221	
	KWM180M	2-3/4"	2"	3-1/8"	2-1/2"	—	Brick Mould Louvers / Trim MLDWM180	

*Keystones K6 and K8 are not molded on back side.

Louvered Shutter

with Center Rail

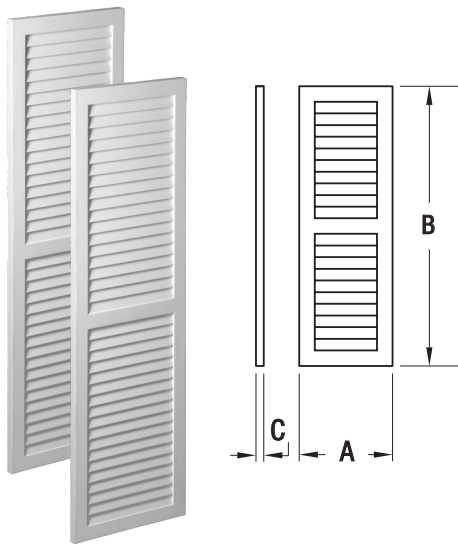

Part Number	Width (A)	Height (B)	Projection (C)
LVSH12X36FNCR	12"	36"	1"
LVSH12X48FNCR	12"	48"	1"
LVSH16X54FNCR	16"	54"	1"
LVSH16X60FNCR	16"	60"	1"
LVSH16X72FNCR	16"	72"	1"
LVSH18X60FNCR	18"	60"	1"
LVSH18X66FNCR	18"	66"	1"
LVSH18X72FNCR	18"	72"	1"
LVSH24X60FNCR	24"	60"	1"
LVSH24X72FNCR	24"	72"	1"

Louvered Shutter

without Center Rail

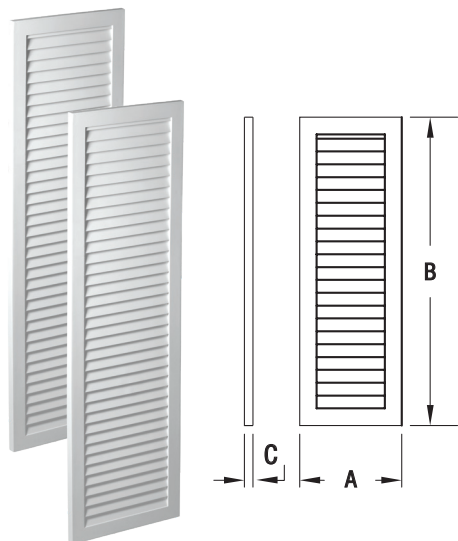

Part Number	Width (A)	Height (B)	Projection (C)
LVSH16X54FNB	16"	54"	1"
LVSH16X72FNB	16"	72"	1"
LVSH18X54FNB	18"	54"	1"
LVSH18X60FNB	18"	60"	1"
LVSH18X72FNB	18"	72"	1"
LVSH24X60FNB	24"	60"	1"
LVSH24X72FNB	24"	72"	1"

**NEW
SIZE**



Raised Panel Shutter

Double Panel

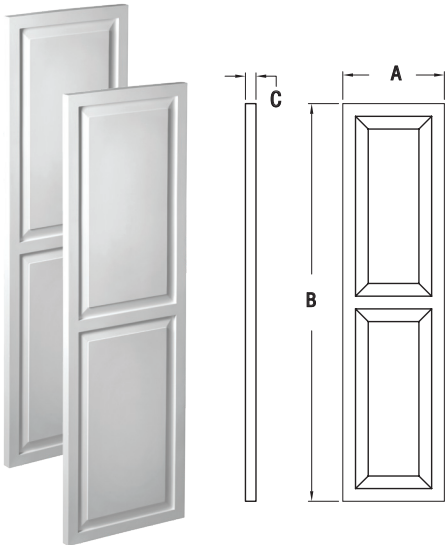

Part Number	Width (A)	Height (B)	Projection (C)
SH16X48DP	16"	48"	1-1/4"
SH16X54DP	16"	54"	1-1/4"
SH16X60DP	16"	60"	1-1/4"
SH16X65DP	16"	65"	1-1/4"
SH16X72DP	16"	72"	1-1/4"
SH18X53DP	18"	53"	1-1/4"
SH18X59DP	18"	59"	1-1/4"
SH18X60DP New Size	18"	60"	1-1/4"
SH18X66DP	18"	66"	1-1/4"
SH18X72DP	18"	72"	1-1/4"
SH24X48DP	24"	48"	1-1/4"
SH24X66DP	24"	66"	1-1/4"

Modern Farmhouse Shaker-Style Shutters



See the product through your mobile device at fypon.com/AR

- Available in widths measuring 12", 16", 18" and 24", and heights measuring 24" – 120" in 1" increments.
- 2" wide stiles and 2-1/2" wide batten create the X-batten design.
- Stiles 1-3/8" deep with 5/8" recessed panel.
- Shaker-style shutter panels and flat trim are available to create your own farmhouse design, details on page 70.

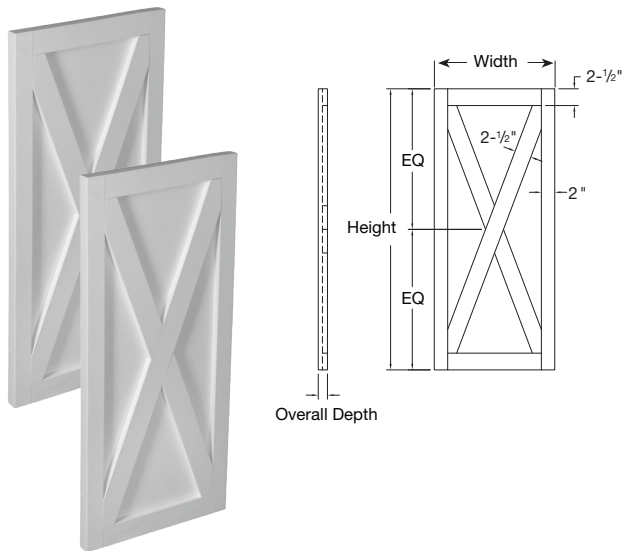

Part numbers shown reflect common sizes.
For additional options, follow the part number logic below or contact your **Fypon®** representative.

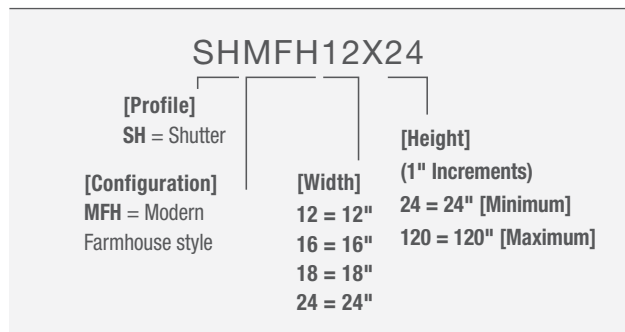

12"	16"	18"	24"
SHMFH12X24	SHMFH16X24	SHMFH18X24	SHMFH24X24
SHMFH12X36	SHMFH16X36	SHMFH18X36	SHMFH24X36
SHMFH12X48	SHMFH16X48	SHMFH18X48	SHMFH24X48
SHMFH12X60	SHMFH16X60	SHMFH18X60	SHMFH24X60
SHMFH12X72	SHMFH16X72	SHMFH18X72	SHMFH24X72
SHMFH12X84	SHMFH16X84	SHMFH18X84	SHMFH24X84
SHMFH12X96	SHMFH16X96	SHMFH18X96	SHMFH24X96
SHMFH12X108	SHMFH16X108	SHMFH18X108	SHMFH24X108
SHMFH12X120	SHMFH16X120	SHMFH18X120	SHMFH24X120





Shaker-Style Shutters

- Features 2-flat panel recessed stile and rail design.
- Available in widths measuring 12", 16", 18" and 24", and heights measuring 24" – 120" in 1" increments.
- 2" wide stiles with 2-1/2" wide rails. Center rail is positioned in the center of the shutter.
- Stiles 1-3/8" deep with 5/8" recessed panel.
- Shaker-style shutter panels and flat trim are available to create your own Craftsman design, details on page 70.

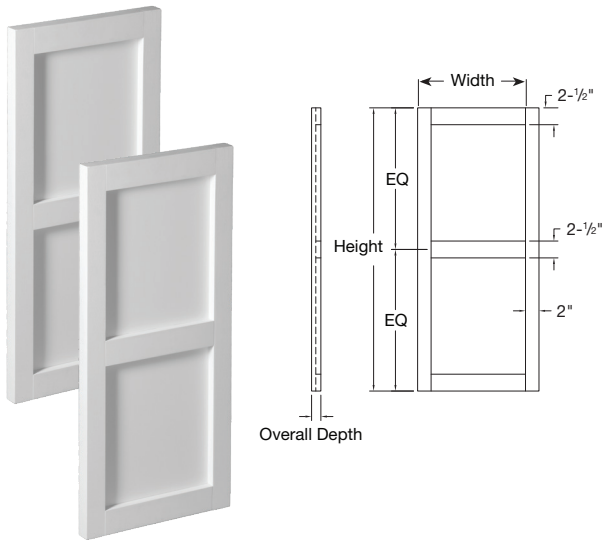

Part numbers shown reflect common sizes. For additional options, follow the part number logic below or contact your **Fypon®** representative.

SH2FP12X24





[Profile] SH = Shutter		
[Configuration] 2FP = 2-Flat Panel	[Width] 12 = 12" 16 = 16" 18 = 18" 24 = 24"	[Height] (1" Increments) 24 = 24" [Minimum] 120 = 120" [Maximum]

12"	16"	18"	24"
SH2FP12X24	SH2FP16X24	SH2FP18X24	SH2FP24X24
SH2FP12X36	SH2FP16X36	SH2FP18X36	SH2FP24X36
SH2FP12X48	SH2FP16X48	SH2FP18X48	SH2FP24X48
SH2FP12X60	SH2FP16X60	SH2FP18X60	SH2FP24X60
SH2FP12X72	SH2FP16X72	SH2FP18X72	SH2FP24X72
SH2FP12X84	SH2FP16X84	SH2FP18X84	SH2FP24X84
SH2FP12X96	SH2FP16X96	SH2FP18X96	SH2FP24X96
SH2FP12X108	SH2FP16X108	SH2FP18X108	SH2FP24X108
SH2FP12X120	SH2FP16X120	SH2FP18X120	SH2FP24X120

Note: Shutters are sold as a set.

Shutter Board Fabrication Panels

For Shaker-Style and Modern Farmhouse Shaker-Style Shutters

	Individual Sheet Part Number	Width	Length	Thickness
	SHSFP12X144	12"	144"	1-3/8"
	SHSFP16X144	16"	144"	1-3/8"
	SHSFP18X144	18"	144"	1-3/8"
	SHSFP24X144	24"	144"	1-3/8"
	FLT1X3-12	2-1/2"	144"	3/4"

Pro Tip Fabricate custom shutter designs for a tailored look.

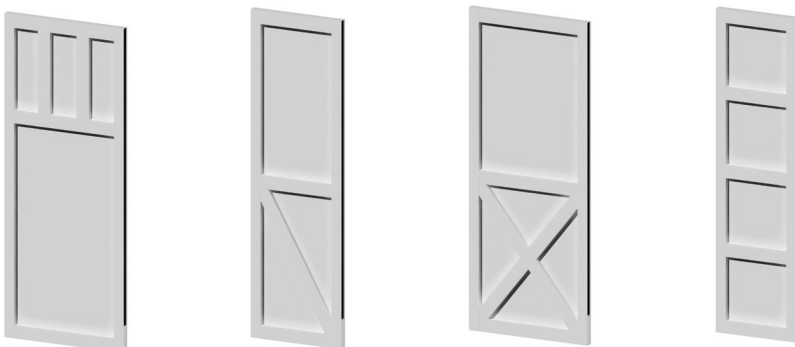



Wood-Grained Shutters



Get the size and style you need.

- Our expanded line includes multiple styles and sizes, with widths measuring 12", 14", 18", and 24", and heights measuring 24"- 120" in 1" increments.
- Accessory line of hinges and clavos creates a distinct look for your shutters.
- Stain or paint shutter and shutter accessories.
- Available in both Board & Batten and Plank styles.

BOARD & BATTEN – JOINED BOARD AND BATTEN STYLES



2 or 3 Batten
Batten styles with joined boards.



End Batten
Battens are placed at the very end of the boards.



Z Batten
Horizontal and diagonal battens form Z shape.



Quarter Round
Mirrors unique arch top windows.



Elliptical
Mirrors the shape of unique elliptical windows.

PLANK – SPACED BOARDS CREATE VISIBILITY OF SIDING BETWEEN SHUTTER BOARDS



2 or 3 Batten
Batten styles with spaced boards.



Z Batten
Horizontal and diagonal battens form Z shape.



Diamond
Decorative diamond shape is centered between the panels.



Elliptical
Mirrors the shape of unique elliptical windows.

Board & Batten Part Number Logic:

Plank Part Number Logic:

SH3PC18X60RS

[Profile] SH = Shutter		[Texture] RS = Rough Sawn Stain or Paint	
[Configuration]		[Height] (1" increments)	
2PC = 2-Board, 2-Batten	2PZC = 2-Board, Z-Batten	24 = 24" [Minimum]	
3PC = 3-Board, 2-Batten	3PZC = 3-Board, Z-Batten	120 = 120" [Maximum]	
4PC = 4-Board, 2-Batten	4PZC = 4-Board, Z-Batten		
[Width]			
2P3BC = 2-Board, 3-Batten	2PEBC = 2-Board, End Batten	12 = 12"	
3P3BC = 3-Board, 3-Batten	3PEBC = 3-Board, End Batten	14 = 14"	
4P3BC = 4-Board, 3-Batten	4PEBC = 4-Board, End Batten	18 = 18"	
		24 = 24"	

SH3P018X60RS

[Profile] SH = Shutter		[Texture] RS = Rough Sawn Stain or Paint	
[Configuration]		[Height] (1" increments)	
2P0 = 2-Plank, 2-Batten	2PZ = 2-Plank, Z-Batten	24 = 24" [Minimum]	
3P0 = 3-Plank, 2-Batten	3PZ = 3-Plank, Z-Batten	120 = 120" [Maximum]	
4P0 = 4-Plank, 2-Batten	4PZ = 4-Plank, Z-Batten		
[Width]			
2P3B = 2-Plank, 3-Batten	2PD = 2-Plank, Diamond	12 = 12"	
3P3B = 3-Plank, 3-Batten	3PD = 2-Plank, Diamond	18 = 18"	
4P3B = 4-Plank, 3-Batten	4PD = 2-Plank, Diamond	24 = 24"	

Quarter Round Part Number Logic:

SH3PHLR18X60RS

[Profile] SH = Shutter		[Texture] RS = Rough Sawn Stain or Paint	
[Configuration]		[Height] (1" increments)	
2PHLR = 2-Board Quarter		24 = 24" [Minimum]	
3PHLR = 3-Board Quarter		120 = 120" [Maximum]	
4PHLR = 4-Board Quarter			
[Width]			
		12 = 12"	
		14 = 14"	
		18 = 18"	
		24 = 24"	

Note: Minimum height for Quarter Round shutters is double the width of the shutter.

Example: SH3PHLR18x36RS – 18" = width of shutter and 36" = height (twice the width).

Board & Batten Shutters — 2-Batten

Rough Sawn Cedar



12" 2-Board, 2-Batten	14" 3-Board, 2-Batten	18" 3-Board, 2-Batten	24" 4-Board, 2-Batten
SH2PC12X24RS	SH3PC14X24RS	SH3PC18X24RS	SH4PC24X24RS
SH2PC12X36RS	SH3PC14X36RS	SH3PC18X36RS	SH4PC24X36RS
SH2PC12X48RS	SH3PC14X48RS	SH3PC18X48RS	SH4PC24X48RS
SH2PC12X60RS	SH3PC14X60RS	SH3PC18X60RS	SH4PC24X60RS
SH2PC12X72RS	SH3PC14X72RS	SH3PC18X72RS	SH4PC24X72RS
SH2PC12X84RS	SH3PC14X84RS	SH3PC18X84RS	SH4PC24X84RS
SH2PC12X96RS	SH3PC14X96RS	SH3PC18X96RS	SH4PC24X96RS
SH2PC12X108RS	SH3PC14X108RS	SH3PC18X108RS	SH4PC24X108RS
SH2PC12X120RS	SH3PC14X120RS	SH3PC18X120RS	SH4PC24X120RS

Part numbers shown reflect common sizes. For additional options, follow the part number logic below or contact your **Fypon®** representative.

SH2PC12X24RS

<p>[Profile] SH = Shutter</p>	<p>[Texture] RS = Rough Sawn</p>
<p>[Configuration] 2PC = 2-Board, 2-Batten 3PC = 3-Board, 2-Batten 4PC = 4-Board, 2-Batten</p>	<p>[Height] (1" increments) 24 = 24" [Minimum] 120 = 120" [Maximum]</p>
<p>[Width] 12 = 12" 14 = 14" 18 = 18" 24 = 24"</p>	



Board & Batten Shutters — 3-Batten

Rough Sawn Cedar



12" 2-Board, 3-Batten	14" 3-Board, 3-Batten	18" 3-Board, 3-Batten	24" 4-Board, 3-Batten
SH2P3BC12X24RS	SH3P3BC14X24RS	SH3P3BC18X24RS	SH4P3BC24X24RS
SH2P3BC12X36RS	SH3P3BC14X36RS	SH3P3BC18X36RS	SH4P3BC24X36RS
SH2P3BC12X48RS	SH3P3BC14X48RS	SH3P3BC18X48RS	SH4P3BC24X48RS
SH2P3BC12X60RS	SH3P3BC14X60RS	SH3P3BC18X60RS	SH4P3BC24X60RS
SH2P3BC12X72RS	SH3P3BC14X72RS	SH3P3BC18X72RS	SH4P3BC24X72RS
SH2P3BC12X84RS	SH3P3BC14X84RS	SH3P3BC18X84RS	SH4P3BC24X84RS
SH2P3BC12X96RS	SH3P3BC14X96RS	SH3P3BC18X96RS	SH4P3BC24X96RS
SH2P3BC12X108RS	SH3P3BC14X108RS	SH3P3BC18X108RS	SH4P3BC24X108RS
SH2P3BC12X120RS	SH3P3BC14X120RS	SH3P3BC18X120RS	SH4P3BC24X120RS

Part numbers shown reflect common sizes. For additional options, follow the part number logic below or contact your Fypon® representative.

SH2P3BC12X24RS

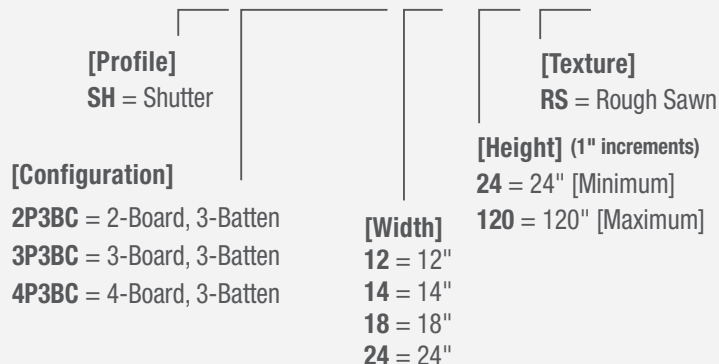

Board & Batten Shutters — End Batten

Rough Sawn Cedar



12" 2-Board, End Batten	14" 3-Board, End Batten	18" 3-Board, End Batten	24" 4-Board, End Batten
SH2PEBC12X24RS	SH3PEBC14X24RS	SH3PEBC18X24RS	SH4PEBC24X24RS
SH2PEBC12X36RS	SH3PEBC14X36RS	SH3PEBC18X36RS	SH4PEBC24X36RS
SH2PEBC12X48RS	SH3PEBC14X48RS	SH3PEBC18X48RS	SH4PEBC24X48RS
SH2PEBC12X60RS	SH3PEBC14X60RS	SH3PEBC18X60RS	SH4PEBC24X60RS
SH2PEBC12X72RS	SH3PEBC14X72RS	SH3PEBC18X72RS	SH4PEBC24X72RS
SH2PEBC12X84RS	SH3PEBC14X84RS	SH3PEBC18X84RS	SH4PEBC24X84RS
SH2PEBC12X96RS	SH3PEBC14X96RS	SH3PEBC18X96RS	SH4PEBC24X96RS
SH2PEBC12X108RS	SH3PEBC14X108RS	SH3PEBC18X108RS	SH4PEBC24X108RS
SH2PEBC12X120RS	SH3PEBC14X120RS	SH3PEBC18X120RS	SH4PEBC24X120RS

Part numbers shown reflect common sizes. For additional options, follow the part number logic below or contact your Fypon® representative.

SH2PEBC12X24RS

<p>[Profile] SH = Shutter</p>	<p>[Configuration] 2PEBC = 2-Board, End Batten 3PEBC = 3-Board, End Batten 4PEBC = 4-Board, End Batten</p>	<p>[Texture] RS = Rough Sawn</p> <p>[Height] (1" increments) 24 = 24" [Minimum] 120 = 120" [Maximum]</p> <p>[Width] 12 = 12" 14 = 14" 18 = 18" 24 = 24"</p>
--	---	--

Board & Batten Shutters — Z-Batten

Rough Sawn Cedar



Window & Door Trim

12" 2-Board, Z-Batten	14" 3-Board, Z-Batten	18" 3-Board, Z-Batten	24" 4-Board, Z-Batten
SH2PZC12X24RS	SH3PZC14X24RS	SH3PZC18X24RS	SH4PZC24X24RS
SH2PZC12X36RS	SH3PZC14X36RS	SH3PZC18X36RS	SH4PZC24X36RS
SH2PZC12X48RS	SH3PZC14X48RS	SH3PZC18X48RS	SH4PZC24X48RS
SH2PZC12X60RS	SH3PZC14X60RS	SH3PZC18X60RS	SH4PZC24X60RS
SH2PZC12X72RS	SH3PZC14X72RS	SH3PZC18X72RS	SH4PZC24X72RS
SH2PZC12X84RS	SH3PZC14X84RS	SH3PZC18X84RS	SH4PZC24X84RS
SH2PZC12X96RS	SH3PZC14X96RS	SH3PZC18X96RS	SH4PZC24X96RS
SH2PZC12X108RS	SH3PZC14X108RS	SH3PZC18X108RS	SH4PZC24X108RS
SH2PZC12X120RS	SH3PZC14X120RS	SH3PZC18X120RS	SH4PZC24X120RS

Part numbers shown reflect common sizes. For additional options, follow the part number logic below or contact your **Fypon®** representative.

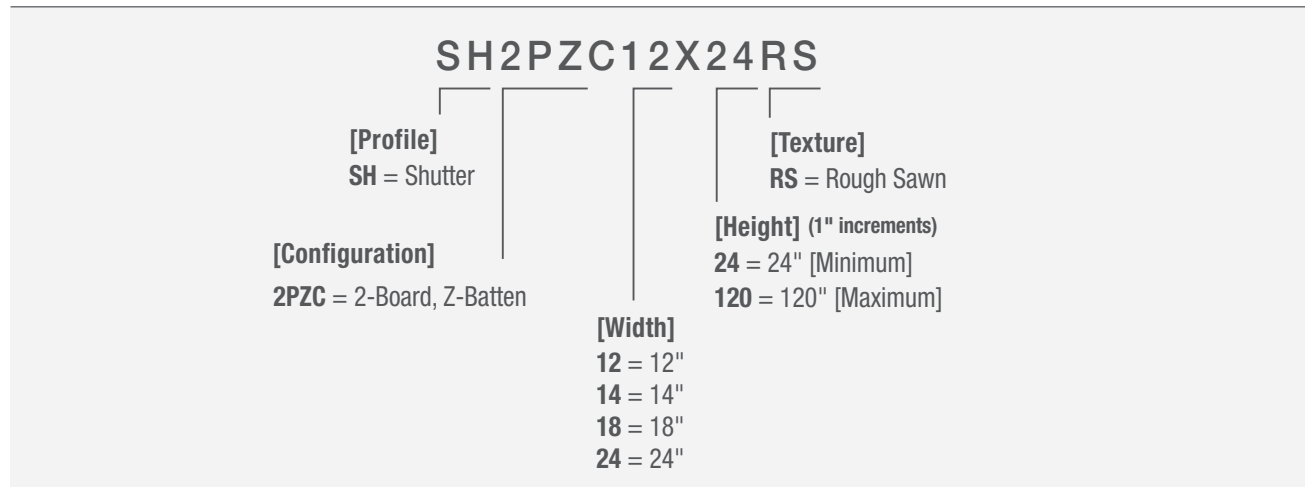



Board & Batten Shutters — Quarter Round

Rough Sawn Cedar



12" 2-Board, Quarter Round	14" 3-Board, Quarter Round	18" 3-Board, Quarter Round	24" 4-Board, Quarter Round
SH2PHLR12X24RS	—	—	—
SH2PHLR12X36RS	SH3PHLR14X36RS	SH3PHLR18X36RS	—
SH2PHLR12X48RS	SH3PHLR14X48RS	SH3PHLR18X48RS	SH4PHLR24X48RS
SH2PHLR12X60RS	SH3PHLR14X60RS	SH3PHLR18X60RS	SH4PHLR24X60RS
SH2PHLR12X72RS	SH3PHLR14X72RS	SH3PHLR18X72RS	SH4PHLR24X72RS
SH2PHLR12X84RS	SH3PHLR14X84RS	SH3PHLR18X84RS	SH4PHLR24X84RS
SH2PHLR12X96RS	SH3PHLR14X96RS	SH3PHLR18X96RS	SH4PHLR24X96RS
SH2PHLR12X108RS	SH3PHLR14X108RS	SH3PHLR18X120RS	SH4PHLR24X108RS
SH2PHLR12X120RS	SH3PHLR14X120RS	SH3PHLR18X120RS	SH4PHLR24X120RS

Part numbers shown reflect common sizes. For additional options, follow the part number logic below or contact your Fypon® representative.

SH2PHLR12X24RS

[Profile]

SH = Shutter

[Texture]

RS = Rough Sawn

[Configuration]

2PHLR = 3-Board, Quarter Round

3PHLR = 3-Board, Quarter Round

4PHLR = 4-Board, Quarter Round

[Height] (1" increments)

24 = 24" [Minimum]

120 = 120" [Maximum]

[Width]

12 = 12"

14 = 14"

18 = 18"

24 = 24"

Note: Minimum height for Quarter Round shutters is double the width of the shutter.

SH2PHLR14X28RS - 14" = width of shutter and 28" = height (twice the width).



Additional Sizes Available

Shutters measuring 24" – 120", in 1" increments, are available at standard lead time.

Elliptical Shutters — Board & Batten

Rough Sawn Cedar



Part Number Logic:

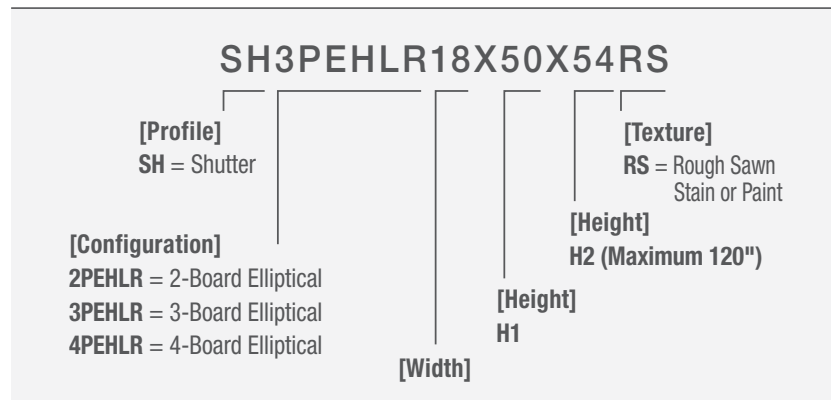

Note: Minimum height (H2) for Elliptical Board & Batten shutters is double the width of the shutter. Example: SH3PEHLR18X35X36RS – 18" = width of shutter and 36" = height (twice the width). If a specific radius is required to complement an elliptical-shaped window, contact your customer service representative to order.

To order an Elliptical Board & Batten shutter that complements the arch of the window, provide measurements of **H1** (in 1/4" increments) and **H2** (in 1" increments) in your part number. See drawing for specific measurement points.

Example:

SH3PEHLR18X50X54RS

W
(H1)
(H2)

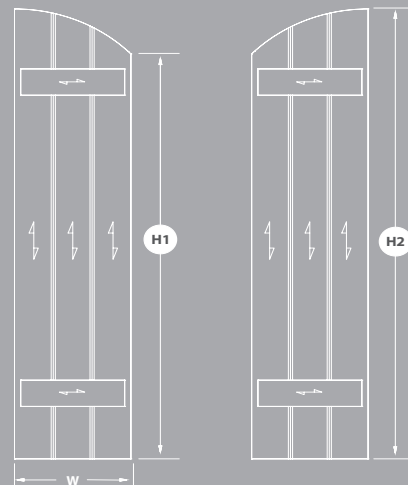

Plank Shutters — 2-Batten

Rough Sawn Cedar



12" 2-Board, 2-Batten	18" 3-Board, 2-Batten	24" 4-Board, 2-Batten
SH2P012X24RS	SH3P018X24RS	SH4P024X24RS
SH2P012X36RS	SH3P018X36RS	SH4P024X36RS
SH2P012X48RS	SH3P018X48RS	SH4P024X48RS
SH2P012X60RS	SH3P018X60RS	SH4P024X60RS
SH2P012X72RS	SH3P018X72RS	SH4P024X72RS
SH2P012X84RS	SH3P018X84RS	SH4P024X84RS
SH2P012X96RS	SH3P018X96RS	SH4P024X96RS
SH2P012X108RS	SH3P018X108RS	SH4P024X108RS
SH2P012X120RS	SH3P018X120RS	SH4P024X120RS

Part numbers shown reflect common sizes. For additional options, follow the part number logic below or contact your **Fypon®** representative.

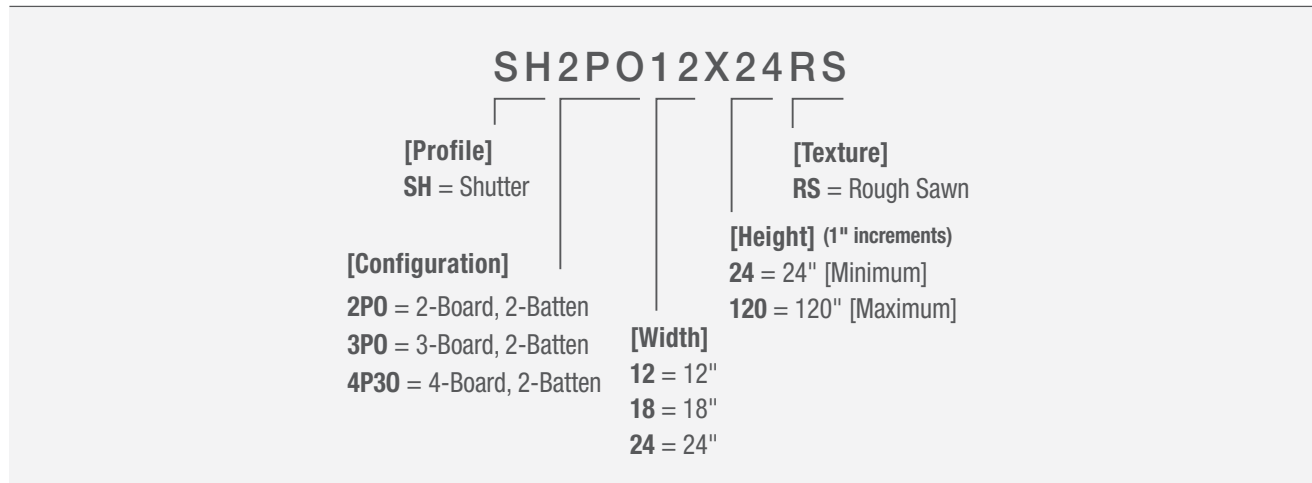



Plank Shutters — 3-Batten

Rough Sawn Cedar



Window & Door Trim

12" 2-Board, 3-Batten	18" 3-Board, 3-Batten	24" 4-Board, 3-Batten
SH2P3B12X24RS	SH3P3B18X24RS	SH4P3B24X24RS
SH2P3B12X36RS	SH3P3B18X36RS	SH4P3B24X36RS
SH2P3B12X48RS	SH3P3B18X48RS	SH4P3B24X48RS
SH2P3B12X60RS	SH3P3B18X60RS	SH4P3B24X60RS
SH2P3B12X72RS	SH3P3B18X72RS	SH4P3B24X72RS
SH2P3B12X84RS	SH3P3B18X84RS	SH4P3B24X84RS
SH2P3B12X96RS	SH3P3B18X96RS	SH4P3B24X96RS
SH2P3B12X108RS	SH3P3B18X108RS	SH4P3B24X108RS
SH2P3B12X120RS	SH3P3B18X120RS	SH4P3B24X120RS

Part numbers shown reflect common sizes. For additional options, follow the part number logic below or contact your **Fypon®** representative.

SH2P3B12X24RS

[Profile]

SH = Shutter

[Texture]

RS = Rough Sawn

[Configuration]

2P3B = 2-Board, 2-Batten

3P3B = 3-Board, 2-Batten

4P3B = 4-Board, 2-Batten

[Height] (1" increments)

24 = 24" [Minimum]

120 = 120" [Maximum]

[Width]

12 = 12"

18 = 18"

24 = 24"

Plank Shutters — Z-Batten

Rough Sawn Cedar



12" 2-Board, Z-Batten	18" 3-Board, Z-Batten	24" 4-Board, Z-Batten
SH2PZ12X24RS	SH3PZ18X24RS	SH4PZ24X24RS
SH2PZ12X36RS	SH3PZ18X36RS	SH4PZ24X36RS
SH2PZ12X48RS	SH3PZ18X48RS	SH4PZ24X48RS
SH2PZ12X60RS	SH3PZ18X60RS	SH4PZ24X60RS
SH2PZ12X72RS	SH3PZ18X72RS	SH4PZ24X72RS
SH2PZ12X84RS	SH3PZ18X84RS	SH4PZ24X84RS
SH2PZ12X96RS	SH3PZ18X96RS	SH4PZ24X96RS
SH2PZ12X108RS	SH3PZ18X108RS	SH4PZ24X108RS
SH2PZ12X120RS	SH3PZ18X120RS	SH4PZ24X120RS

Part numbers shown reflect common sizes. For additional options, follow the part number logic below or contact your Fypon® representative.

SH2PZ12X24RS

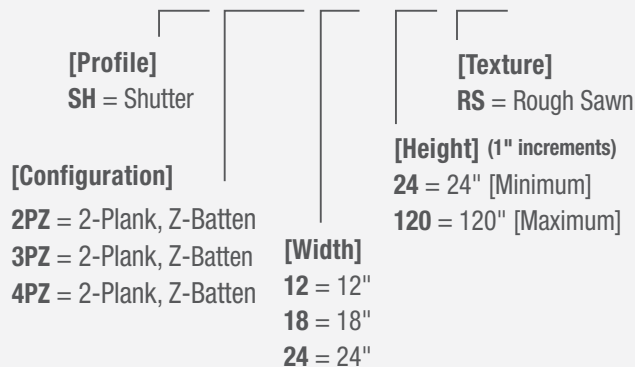

Plank Shutters — Diamond

Rough Sawn Cedar



12" 2-Board, Diamond	18" 3-Board, Diamond	24" 4-Board, Diamond
SH2PD12X24RS	SH3PD18X24RS	SH4PD24X24RS
SH2PD12X36RS	SH3PD18X36RS	SH4PD24X36RS
SH2PD12X48RS	SH3PD18X48RS	SH4PD24X48RS
SH2PD12X60RS	SH3PD18X60RS	SH4PD24X60RS
SH2PD12X72RS	SH3PD18X72RS	SH4PD24X72RS
SH2PD12X84RS	SH3PD18X84RS	SH4PD24X84RS
SH2PD12X96RS	SH3PD18X96RS	SH4PD24X96RS
SH2PD12X108RS	SH3PD18X108RS	SH4PD24X108RS
SH2PD12X120RS	SH3PD18X120RS	SH4PD24X120RS

Part numbers shown reflect common sizes. For additional options, follow the part number logic below or contact your Fypon® representative.

SH2PD12X24RS

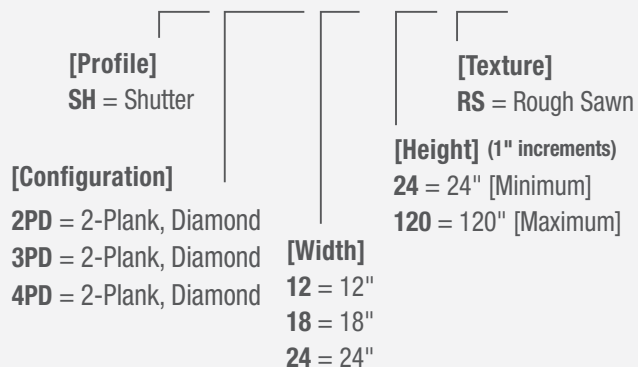



Elliptical Shutters — Plank

Rough Sawn Cedar



Part Number Logic:

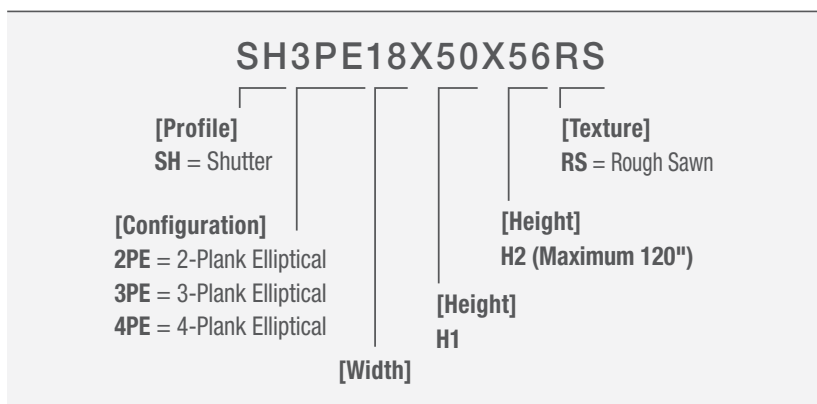

Note: Minimum height (H2) for Elliptical Plank shutters is double the width of the shutter.
 Example: SH3PE18X35X36RS – 18" = width of shutter and 36" = height (twice the width).
 If a specific radius is required to complement an elliptical-shaped window, contact your customer service representative to order.

To order an Elliptical Plank shutter that complements the arch of the window, provide measurements of **H1** (in 1/4" increments) and **H2** (in 1" increments) in your part number. See drawing for specific measurement points.

Example:
 SH3PE18X50X56RS

W
(H1)
(H2)

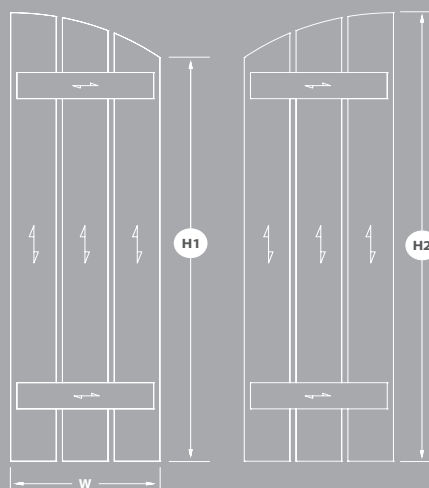

NEW

Double Raised Panel Shutter

Rough Sawn Cedar

Window & Door Trim

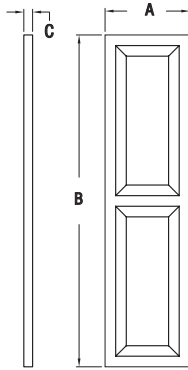





Part Number	Width (A)	Height (B)	Projection (C)
SH16X48DPS New Size	16"	48"	1-1/4"
SH16X60DPS New Size	16"	60"	1-1/4"
SH18X72DPS New Size	18"	72"	1-1/4"



Wood-Grained Shutter Board Fabrication Panels

Rough Sawn Cedar

Individual Sheet Part Number	Width	Length	Thickness
 SHBB12X144RS 2-Board Panel	12"	144"	3/4"
 SHBB14X144RS 3-Board Panel	14"	144"	3/4"
 SHBB18X144RS 3-Board Panel	18"	144"	3/4"
 SHBB24X144RS 4-Board Panel	24"	144"	3/4"
 FLT1X4-12RS* Batten Trim	3-1/2"	144"	3/4"



Shutter Accessories — Hinges

Colonial & Spear

	Part Number	Length		Part Number	Length
	SHHNGCOL10**	10"		SHHNGSPR10**	10"
	SHHNGCOL16**	16"		SHHNGSPR16**	16"

Shutter Accessories — Clavos

Round & Pyramid

	Part Number	Diameter		Part Number	Width
	SHCLARND1.25**	1-1/4"		SHCLAPYR1.25**	1-1/4"
	SHCLARND1.25-8PACK	1-1/4"		SHCLAPYR1.25-8PACK	1-1/4"
	SHCLARND1.25-12PACK	1-1/4"		SHCLAPYR1.25-12PACK	1-1/4"
	SHCLARND1.25-18PACK	1-1/4"		SHCLAPYR1.25-18PACK	1-1/4"
	SHCLARND1.25-24PACK	1-1/4"		SHCLAPYR1.25-24PACK	1-1/4"
	SHCLARND1.25-100PACK	1-1/4"		SHCLAPYR1.25-100PACK	1-1/4"



*Sold as a four pack.

**Sold as a set.

Note: Shutter accessories come primed and ready for paint.