

LARSON®

2024 DEALER CATALOG

STORM AND VENTING DOORS • PET-FRIENDLY OPTIONS • RETRACTABLE SCREENS



MANIFEST YOUR OUTER HOME



Open the full potential of your entry – season after season.

For more than 70 years, we've perfected storm doors designed to let the best of nature in while keeping the worst out.

Table of Contents

INTRODUCTION	4-7
Sales Policy	4
Sales Distribution Centers	5
Special Projects	6
Helpful Resources	7
PLATINUM COLLECTION	8-19
456 Retractable Screen	10-11
459 Interchangeable Full Glass	12-13
449 Secure Glass	14-15
450 Secure Screen	16-17
Measuring Guide	
Platinum Collection	18-19
STORM DOORS	20-45
Full Glass & Screen	
149 Elegant Selection	22-23
350 Classic-View Fullview	24-25
360-48 WearTuff Full Screen	26-27
Retractable Screen	
146 Easy Vent Selection	28-29
356 Lifestyle Fullview Screen Away	30
830 Lifestyle Midview Screen Away	31
NEW 370-84 Lifestyle 2.0 Midview	
Screen Away	32
691 Lifestyle Highview Screen Away.....	33
Pet-Friendly	
360-79 Classic-View Pet View	34
360-49 Pet Breeze	35
370 Life-Core Pet Single-Vent	36-37
Venting	
370-50 Life-Core Reversa Screen	38
360-16/660-16 Classic-View	
Reversa Screen	39
278-SS Life-Core Single-Vent	40
380-05 Mobile Home Single-Vent	41
ENHANCED 298-SS Life-Core Composite	
Surface Single-Vent	42-43
Measuring Guide	
Storm Doors	44
FRENCH DOOR KITS	46-49
RETRACTABLE SCREEN	
PRODUCTS	50-83
Find the Right Screen	52-53
Brisa Retractable Screen Door	
7721, 7722, 7723	54-55
Feature Overview	56
Additional Sizing and Application Detail	57
Screen Height Position on a Hinged Door	58
Screens for Single Panel Hinged Doors	59
Component Dimensions – Single Screen	60
Screens for Double Panel Hinged Doors	61
Brisa for Sliding Patio Doors.....	62
Retractable Wall Screen	
WS1000/WS2000	64-66
Measuring Guide	
Wall Screen	67

RETRACTABLE SCREEN

PRODUCTS *continued*

Retractable Motorized Screen

Models 6+, 7+, 8+, 9+, 10+	68-69
Insect Screens	70
Solar and Privacy Screens	71
Vinyl Screens	72
Heavy-Duty Bottom Bar	73
Screen Controls	73

Measuring Guide

Retractable Motorized Screen –	
Inside Mount	74
Retractable Motorized Screen –	
Outside Mount	75

Inspire Pleated Retractable Screen Door

IN100	76-77
-------------	-------

Escape® Retractable Screen Door

Escape E100, E200	78-79
Screen Fabric Options	79
Threshold Transitions & Kits	79

Measuring Guide

Single Panel Door Screens	80
Double Panel Door Screens	81

NatureVue Retractable Window Screen

NatureVue NV100	82
-----------------------	----

Measuring Guide

Retractable Window Screen	83
---------------------------------	----

SECURITY STORM DOORS

Guardsman Security Storm Doors

Security Storm Door Models	84-87
Accessories	88
Folding Gate	88

Measuring Guide

Security Storm Doors	89
----------------------------	----

Guardsman Round Top Storm Doors

Fullview Model	90
Courtyard Model	90

Measuring Guide

Round Top Guidelines	91
----------------------------	----

RETAIL HARDWARE

Pneumatic Door Closers	92
Handlesets	93-94
Wind Chains	95
Door Sweeps	95

PARTS & ACCESSORIES

Replacement Closers and	
Miscellaneous Accessories	96
Glass & Screen Inserts	97
Exterior/Interior Handlesets	
with Closer Kits	98
Exterior/Interior Handleset Kits.....	99

Sales Policy



Order the easy way at: larsondoors.com/dealer.

For fast, convenient ordering, use the Larson® Easy Ordering system. Enter orders on your own time with immediate confirmation of costs, freight information and ship dates. To get started, visit larsondoors.com/dealer and provide an email address along with business name, address and contact information. Or, email your account information to: webdealers@larsondoors.com.

EMAIL & TELEPHONE ORDERS

1. Orders will be processed as given. Larson Manufacturing Company, LLC will not be held responsible for errors on email or phone orders.
2. An email confirmation of the order will be sent within a few hours. Please verify the information and call with any changes.
3. Review the order carefully. Orders for custom products may not be modified or canceled once they have been placed. Other orders may be canceled within the first 24 hours.

Note: Prices shown in this catalog are Larson List Prices.

SHIPPING & HANDLING

Ground Delivery:

Shipping and handling charges may apply. All products included.

RETURNS

For material shortages, errors, or damaged or defective product, please notify our office immediately.

Pre-authorization of returns for credit is required for all standard size doors and subject to a 15% restocking charge. If product is returned on a carrier, a freight charge may also be assessed. Do not deduct any credits on returned merchandise from the invoice when remitting. Credit memos will be issued from our corporate office.

Note: Once placed, custom door orders cannot be canceled. For warranty questions please visit larsondoors.com/warranty.

Dealer Line: 1-800-334-1328
Homeowner Helpline: 1-888-483-3768

Sales Distribution Centers



BROOKINGS, SD 222 Sunrise Ridge Rd.
Brookings, SD 57006

JANESVILLE, WI 3920 Kennedy Rd., Suite 110
P.O. Box 1057
Janesville, WI 53545

FOSTORIA, OH 616 N. Corporate Place
Fostoria, OH 44830

N. KANSAS CITY, MO 1231 Atlantic Street
North Kansas City, MO 64116

MOCKSVILLE, NC 125 B Quality Drive
Mocksville, NC 27028

ALLENTOWN, PA 7377 William Avenue
Allentown, PA 18106

ALBERT LEA, MN 1501 Betha Larson Lane
Albert Lea, MN 56007

CORPORATE HEADQUARTERS

Brookings, SD

MANUFACTURING FACILITIES

Brookings, SD
Mocksville, NC

Special project? We've got you covered.

Our team is ready to assist with your special requests, custom product orders and volume buys. Price quotes on all Larson® products are available for special building projects. Minimum quantities may apply. Stock replenishment excluded.



BULK & SPECIALITY ORDERS

To receive quotes for large quantity and specialty orders, email: quotes@larsondoors.com

STANDARD ORDER QUOTES

To receive quotes for non-specialty, low-volume orders, email: dealerdirect@larsondoors.com or call: 1-800-334-1328

Helpful Resources

Warranty Documents

Enjoy with confidence. Find complete product and component warranties by scanning the QR code or visiting larsondoors.com/warranty.



Warranty Documents

Measuring Guides

Get the right fit. Use the measuring guides at the end of each product section to order the correct size for your project. Follow the table of contents on page 3 to quickly find the right guide. Find additional information about measuring for storm doors at larsondoors.com/storm-doors/storm-doors-how-to-measure.

Replacement Parts

Missing or broken part? Find a replacement in pages 96–99 or order online at parts.larsondoors.com.

Customer Service

Need help? We have the expertise and resources to help you with all your product, installation or warranty questions. Visit us at larsondoors.com/support to explore our library of resources or to talk to us directly by phone or chat.



Model Shown: 8+ Retractable Motorized Screen
SunTex 95 Screen in Black

Platinum

COLLECTION

The Platinum Collection delivers sleek, modern design and offers premium standard features including a multi-point locking system, hidden built-in closer with Click&Hold™ technology and triple weatherstrip.



PLATINUM SECURITY

Enjoy extra peace of mind with the multi-point locking system. QuickFit™ handleset sold separately.



PLATINUM HIDDEN CLOSER

Hidden built-in closer with Click&Hold™ technology to hold the door open.



PLATINUM TRIPLE SEAL

Triple weatherstrip to help protect your home and entry door from harsh weather.

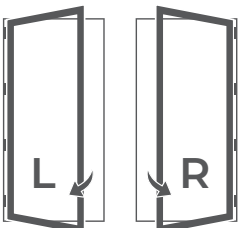

Left-Hinge Right-Hinge

PLATINUM PRE-HUNG DOOR

Select correct hinging as seen from outside.





Model Shown: Platinum 459FV
White Frame with Straight Matte Black QuickFit Handleset



Model Shown: Platinum 456FV
 White Frame with Straight Aged Bronze
 QuickFit Handleset



Platinum Collection 456 Retractable Screen

THE ULTIMATE SCREEN AWAY. MODEL

Discover the most advanced storm door to feature Screen Away, the Platinum Retractable Screen (RS). Invite fresh air into your home with the touch of a finger and enhance your home's style with the feature-rich and elegant design of the Platinum Collection.



LIFETIME
 WARRANTY



10-MINUTE
 INSTALL*



RETRACTABLE
 SCREEN

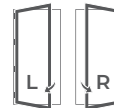

CHOOSE LEFT-
 OR RIGHT-HINGE



UPGRADE TO
 LOW-E GLASS

TOP BENEFITS

- **Robust defense.** Engineered with durable, low-maintenance aluminum and surrounded by a triple weatherstrip to encase the entry against the elements.
- **Instant airflow with a view.** Screen Away® retractable screen disappears above the window for a clear view.
- **Seamless operation.** Hidden built-in closer with Click&Hold™ technology holds the door open without compromising the door's style and stability.
- **10-minute install.*** Pre-assembled for easy surface mount installation. Just place on the opening and secure with pre-attached screws.

ADDITIONAL FEATURES

- Multi-point locking system secures the door at three critical places for extra peace of mind.
- Handleset holes are pre-drilled for immediate installation.
- Hinges are pre-installed for fast mounting and no cutting.
- Pre-assembled screw covers snap tight for a finished look.

FRAME COLORS



LIST PRICE

MODEL	SIZE	WHITE LINEN	PEBBLESTONE	WOODLAND	GRAPHITE	BLACK	QUICKFIT HANDLESET		
456FVE Low-E	32" x 81" 36" x 81"	\$721.00					SINGLE EA. \$60.00 3-PACK*** \$146.00		
456FV Clear	32" x 81" 36" x 81"	\$675.00					STRAIGHT 20298953 Matte Black 20298917 Brushed Nickel 20298957 Aged Bronze		
REGULAR CUSTOM**								CURVED 20297817 Brushed Nickel 20297857 Aged Bronze 20297820 Antique Brass 20297807 Brass	
456FVE Low-E	W: 24" - 36" H: 70" - 86"	\$1,017.00							
456FV Clear		\$962.00							
OVERSIZE CUSTOM**									
456FVE Low-E	W: 36-1/8" - 42" H: 70" - 86-1/8"	\$1,134.00							
456FV Clear		\$1,089.00							

Note: When ordering, select left (L) or right (R) hinge as seen from outside.

QUICKFIT™ HANDLESETS

Sold separately and required to operate the built-in deadbolt on Platinum Collection, 149 Elegant Selection™ and 146 Easy Vent. Selection models. QuickFit handlesets cannot be modified for use with older models.

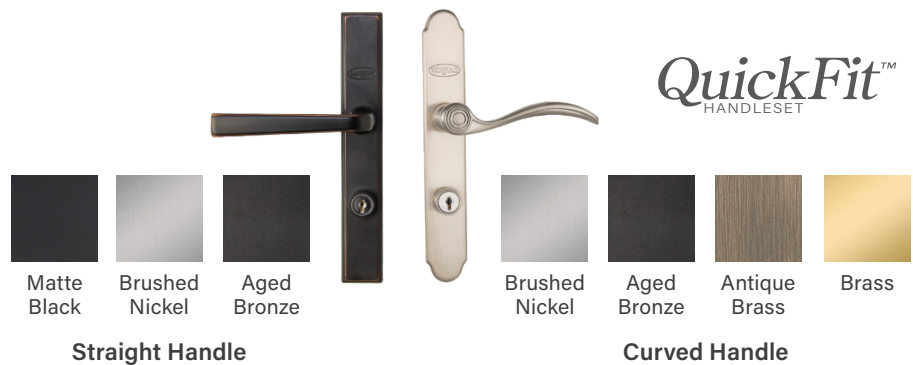

*Preparation time not included. Based on typical installation. Actual times may vary.

**Custom doors have extended, variable lead times. Once placed, custom orders cannot be canceled.

***Order in increments of three (same finish) for reduced pricing.

Note: Larson reserves the right to alter or discontinue any model, specification, warranty or price without notice. Product finish colors are approximate; actual finish colors may vary. See your Larson seller or visit larsondoors.com for details on limited warranties and exclusions.



Model Shown: Platinum 459FV
White Frame with Straight Matte Black
QuickFit Handleset



Platinum Collection 459 Interchangeable Full Glass

OUR ULTIMATE FULL GLASS MODEL

Discover the most advanced storm door to feature interchangeable glass, the Platinum Interchangeable Full Glass (IFG). Welcome each season and enhance your home's style with the feature-rich and elegant design of the Platinum Collection.



LIFETIME
WARRANTY



10-MINUTE
INSTALL*

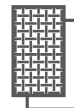

INTERCHANGEABLE
SCREEN & GLASS

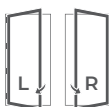

CHOOSE LEFT-
OR RIGHT-HINGE



UPGRADE TO
LOW-E GLASS

TOP BENEFITS

- **Robust defense.** Engineered with durable, low-maintenance aluminum and surrounded by a triple weatherstrip to encase the entry against the elements.
- **Seasonal ventilation, maximum light.** Interchangeable fullview glass and screen open the home to the best of each season, including fresh air in the summer and natural light in the winter.
- **Seamless operation.** Hidden built-in closer with Click&Hold™ technology holds the door open without compromising the door's style and stability.
- **10-minute install.*** Pre-assembled for easy surface mount installation. Just place on the opening and secure with pre-attached screws.

ADDITIONAL FEATURES

- Multi-point locking system secures the door at three critical places for extra peace of mind.
- Handleset holes are pre-drilled for immediate installation.
- Hinges are pre-installed for fast mounting and no cutting.
- Pre-assembled screw covers snap tight for a finished look.

FRAME COLORS



LIST PRICE

MODEL	SIZE	WHITE LINEN	PEBBLESTONE	WOODLAND	GRAPHITE	BLACK
459FVE Low-E	32" x 81" 36" x 81"	\$682.00				
459FV Clear	32" x 81" 36" x 81"	\$618.00				
REGULAR CUSTOM**						
459FVE Low-E	W: 24" - 36" H: 75" - 85"	\$895.00				
459FV Clear		\$805.00				
OVERSIZE CUSTOM**						
459FVE Low-E	W: 36-1/8" - 42" H: 75" - 85"	\$962.00				
459FV Clear		\$873.00				
OVERSIZE PLUS CUSTOM**						
459FVE Low-E	W: up to 42" H: 85-1/8" - 97"	\$1,029.00				
459FV Clear		\$940.00				

QUICKFIT HANDLESET	
SINGLE EA. \$60.00	3-PACK*** \$146.00
STRAIGHT 20298953 Matte Black 20298917 Brushed Nickel 20298957 Aged Bronze	
CURVED 20297817 Brushed Nickel 20297857 Aged Bronze 20297820 Antique Brass 20297807 Brass	

Note: When ordering, select left (L) or right (R) hinge as seen from outside.

QUICKFIT™ HANDLESETS

Sold separately and required to operate the built-in deadbolt on Platinum Collection, 149 Elegant Selection™ and 146 Easy Vent. Selection models. QuickFit handlesets cannot be modified for use with older models.

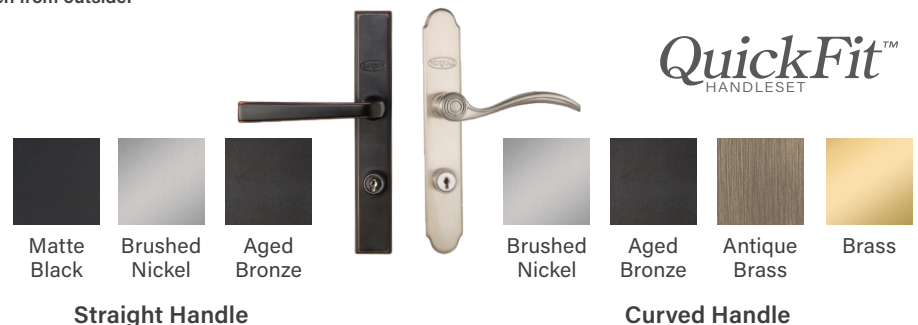

*Preparation time not included. Based on typical installation. Actual times may vary.

**Custom doors have extended, variable lead times. Once placed, custom orders cannot be canceled.

***Order in increments of three (same finish) for reduced pricing.

Note: Larson reserves the right to alter or discontinue any model, specification, warranty or price without notice. Product finish colors are approximate; actual finish colors may vary. See your Larson seller or visit larsondoors.com for details on limited warranties and exclusions.



Model Shown: Platinum 449
White Frame with Straight Brushed Nickel QuickFit Handleset



Platinum Collection 449 Secure Glass

OUR ULTIMATE SECURITY STORM DOOR

Discover our most advanced security storm door, the Platinum Secure Glass (SG). Give your entry an exceptional layer of security while maximizing your home's natural light and style with the feature-rich and elegant design of the Platinum Collection.



LIFETIME WARRANTY



10-MINUTE INSTALL*



DOMINATOR GLASS

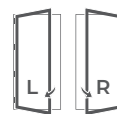

CHOOSE LEFT-OR RIGHT-HINGE

TOP BENEFITS

- **Robust defense.** Engineered with durable, low-maintenance aluminum and surrounded by a triple weatherstrip to encase the entry against the elements.
- **Enhanced security.** Dominator™ shield between two glass panels helps keep intruders out. Includes Break-in Protection warranty.
- **Seamless operation.** Hidden built-in closer with Click&Hold™ technology holds the door open without compromising the door's style and stability.
- **10-minute install.*** Pre-assembled for easy surface mount installation. Just place on the opening and secure with pre-attached screws.

ADDITIONAL FEATURES

- Multi-point locking system secures the door at three critical places for extra peace of mind.
- Handleset holes are pre-drilled for immediate installation.
- Hinges are pre-installed for fast mounting and no cutting.
- Pre-assembled screw covers snap tight for a finished look.

FRAME COLORS



LIST PRICE

MODEL	SIZE	WHITE LINEN	PEBBLESTONE	WOODLAND	GRAPHITE	BLACK	QUICKFIT HANDLESET			
449-04	32" x 81" 36" x 81"	\$706.00					<table border="1"> <tr> <td>SINGLE EA. \$60.00</td> <td>3-PACK*** \$146.00</td> </tr> </table>		SINGLE EA. \$60.00	3-PACK*** \$146.00
SINGLE EA. \$60.00	3-PACK*** \$146.00									
REGULAR CUSTOM** ✂										
449-04	W: 24" - 36" H: 75" - 85"	\$984.00					STRAIGHT 20298953 Matte Black 20298917 Brushed Nickel 20298957 Aged Bronze			
OVERSIZE CUSTOM** ✂										
449-04	W: 36-1/8" - 42" H: 75" - 85"	\$1,118.00					CURVED 20297817 Brushed Nickel 20297857 Aged Bronze 20297820 Antique Brass 20297807 Brass			
OVERSIZE PLUS CUSTOM** ✂										
449-04	W: 24" - 42" H: 85-1/8" - 97"	\$1,243.00								

Note: When ordering, select left (L) or right (R) hinge as seen from outside.

QUICKFIT™ HANDLESETS

Sold separately and required to operate the built-in deadbolt on Platinum Collection, 149 Elegant Selection™ and 146 Easy Vent® Selection models. QuickFit handlesets cannot be modified for use with older models.

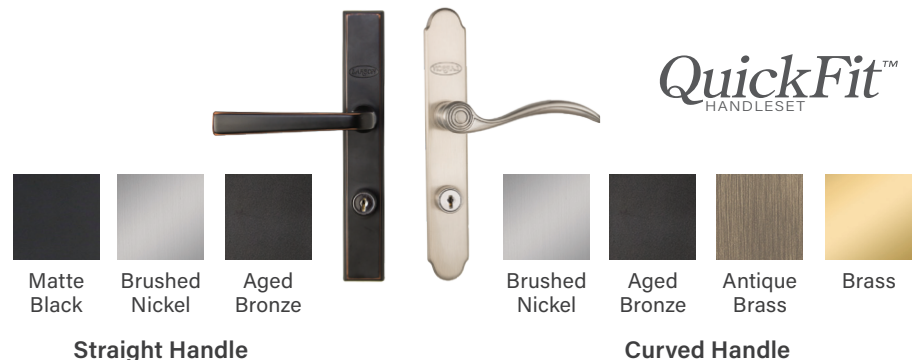

*Preparation time not included. Based on typical installation. Actual times may vary.

**Custom doors have extended, variable lead times. Once placed, custom orders cannot be canceled.

***Order in increments of three (same finish) for reduced pricing.

Note: Larson reserves the right to alter or discontinue any model, specification, warranty or price without notice. Product finish colors are approximate; actual finish colors may vary. See your Larson seller or visit larsondoors.com for details on limited warranties and exclusions.



Model Shown: Platinum 450
White Frame with Straight Brushed Nickel
QuickFit Handleset

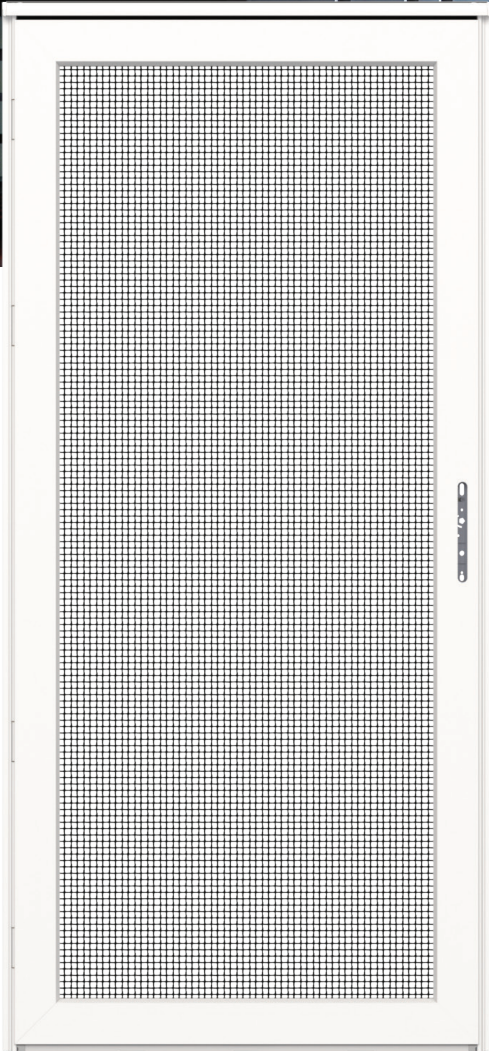

Platinum Collection 450 Secure Screen

OUR ULTIMATE SCREEN DOOR

Discover our most advanced screen door, the Platinum Secure Screen (SCR). Give your entry an exceptional layer of security without sacrificing ventilation or your home's style with the feature-rich and elegant design of the Platinum Collection.



LIFETIME
WARRANTY



10-MINUTE
INSTALL**



DOMINATOR
SCREEN

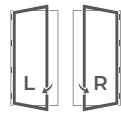

CHOOSE LEFT-
OR RIGHT-HINGE

TOP BENEFITS

- **Robust defense.** Engineered with durable, low-maintenance aluminum and surrounded by a triple weatherstrip to encase the entry against the elements.
- **Enhanced security.** Dominator™ .032" stainless steel mesh is tested to withstand 1,000 lbs. of force to help prevent break-ins.* Includes Break-in Protection warranty.
- **Seamless operation.** Hidden built-in closer with Click&Hold™ technology holds the door open without compromising the door's style and stability.
- **10-minute install.**** Pre-assembled for easy surface mount installation. Just place on the opening and secure with pre-attached screws.

ADDITIONAL FEATURES

- Multi-point locking system secures the door at three critical places for extra peace of mind.
- Handleset holes are pre-drilled for immediate installation.
- Hinges are pre-installed for fast mounting and no cutting.
- Pre-assembled screw covers snap tight for a finished look.

FRAME COLORS



LIST PRICE

MODEL	SIZE	WHITE LINEN	PEBBLESTONE	WOODLAND	GRAPHITE	BLACK
450-18	32" x 81" 36" x 81"	\$948.00				
REGULAR CUSTOM***						
450-18	W: 24" - 36" H: 75" - 85"	\$1,140.00				
OVERSIZE CUSTOM***						
450-18	W: 36-1/8" - 42" H: 75" - 85"	\$1,255.00				
OVERSIZE PLUS CUSTOM***						
450-18	W: 24" - 42" H: 85-1/8" - 97"	\$1,311.00				

QUICKFIT HANDLESET	
SINGLE EA. \$60.00	3-PACK*** \$146.00
STRAIGHT 20298953 Matte Black 20298917 Brushed Nickel 20298957 Aged Bronze	
CURVED 20297817 Brushed Nickel 20297857 Aged Bronze 20297820 Antique Brass 20297807 Brass	

Note: When ordering, select left (L) or right (R) hinge as seen from outside.

QUICKFIT™ HANDLESETS

Sold separately and required to operate the built-in deadbolt on Platinum Collection, 149 Elegant Selection™ and 146 Easy Vent Selection models. QuickFit handlesets cannot be modified for use with older models.

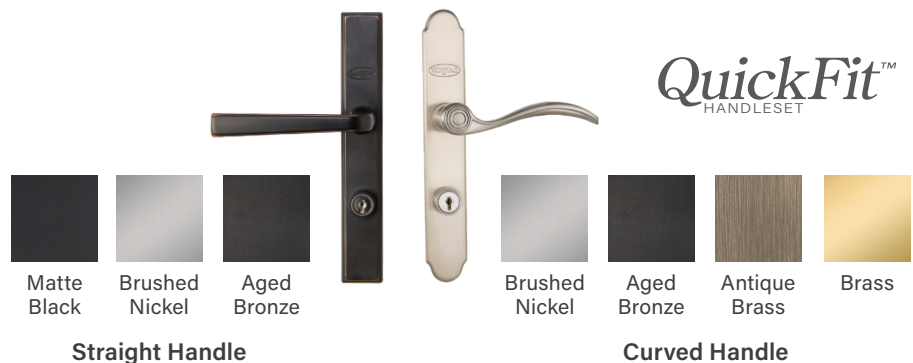

*Stainless steel wire mesh tested to withstand 1,000 lbs. per lineal in. of force.

**Preparation time not included. Based on typical installation. Actual times may vary.

***Custom doors have extended, variable lead times. Once placed, custom orders cannot be canceled.

****Order in increments of three (same finish) for reduced pricing.

Note: Larson reserves the right to alter or discontinue any model, specification, warranty or price without notice.

Product finish colors are approximate; actual finish colors may vary. See your Larson seller or visit larsondoors.com for details on limited warranties and exclusions.

Measuring Guide:

PLATINUM STORM & SECURITY DOORS

The Platinum Collection features our easiest storm door installation system.

Use the diagram below to record your measurements as shown. If the width measurements vary, record the smallest measurement.

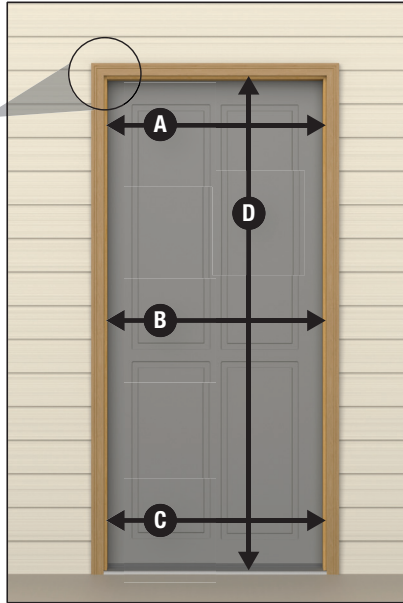
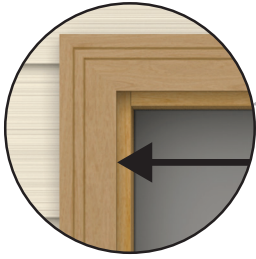

RECORD MEASUREMENTS

A	Width
B	Width
C	Width
D	Height



SURFACE MOUNT

The rails mount directly to the face of the exterior door trim and require 3/4" of clearance on each side and up to 1" of clearance above the opening.

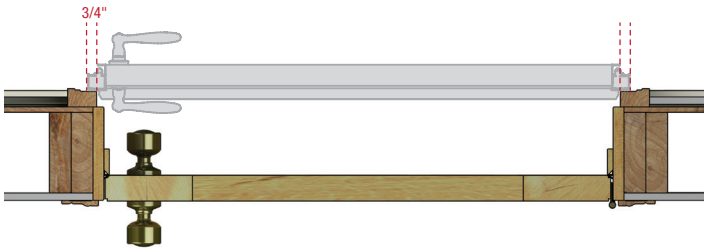

Construction styles may vary.

PRE-HINGED FOR EFFORTLESS INSTALLATION

Select **L** (left-hinge) or **R** (right-hinge) as viewed from outside.

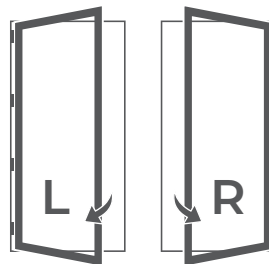

SPECIFY WHEN ORDERING:

- A. Model Number
- B. Color
- C. Required Opening Size (Width x Height)
- D. Platinum Hinge Side (LH or RH)

DOOR OPENING	MIN. WIDTH	MAX. WIDTH	MIN. HEIGHT	MAX. HEIGHT
32" x 81"	31-7/8"	32-3/8"	80"	81"
36" x 81"	35-7/8"	36-3/8"		

Note: Standard size availability varies by model. Custom size doors are made to fit opening size ordered. Custom doors have extended, variable lead times. Once placed, custom orders cannot be canceled. Shims may be required in certain installation applications.



Country
Roads
Take
Me
Home

Our Farm
Est. 2008

Model Shown: Platinum 456FV
Black Frame with Straight Matte Black QuickFit Handleset

Storm Doors

Create the entry that matches your lifestyle from our wide selection of storm doors. Whether you want extra protection for your home, more fresh air and natural light, or freedom for your pet, we have the right door for you.



FULL GLASS & SCREEN

Pages 22-27

Maximum air and light. Most models feature interchangeable glass and screens for seasonal ventilation.



RETRACTABLE SCREENS

Pages 28-33

Screen disappears above the window for a clear view.



PET-FRIENDLY

Pages 34-37

Invite your pet to enjoy the ease of entering and exiting the home with a pre-installed PetSafe® pet flap.



VENTING

Pages 38-43

Built-in screens provide convenient ventilation without any need for seasonal storage.



Model Shown: 370-84 Lifestyle 2.0 Screen Away
Brown Frame





149 Elegant Selection™

TOP BENEFITS

- **Enduring protection.** Constructed with heavy-duty, low-maintenance 1-5/8" thick extruded aluminum and surrounded by a dual weatherstrip for exceptional weather resistance.
- **Seasonal ventilation, maximum light.** The interchangeable fullview glass and screen open the home to the best of each season, including fresh air in the summer and natural light in the winter.
- **Steady convenience.** The two-closer system provides extra stability and features a hold-open button to keep the door open with the tap of a toe.

ADDITIONAL FEATURES

- An overlapping edge helps seal out the elements and delivers a streamlined look that conceals hinges and gaps.
- **149PV*** – Built-in 8" x 12" pet door fits pets up to 40 lbs. and includes a slide-in panel cover.
- Designer screw covers conceal exterior mounting screws.
- Includes self-drilling installation screws.
- The bottom expander helps seal the opening, even in entries with uneven sills.



LIFETIME
WARRANTY



EASY LEFT- OR RIGHT-
HINGE INSTALLATION



INTERCHANGEABLE
SCREEN & GLASS



UPGRADE TO
LOW-E GLASS

Model Shown: 149FVE | 149FV
Fullview with Low-E/Clear

ADDITIONAL MODELS

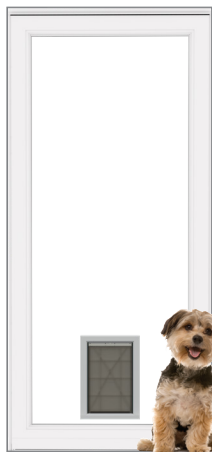

**Pet Door
149PV***

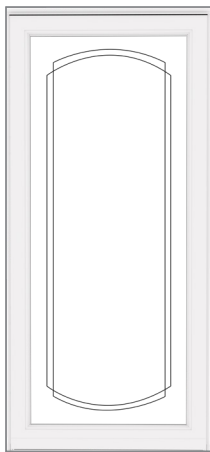

**Bevel Glass
149BV**

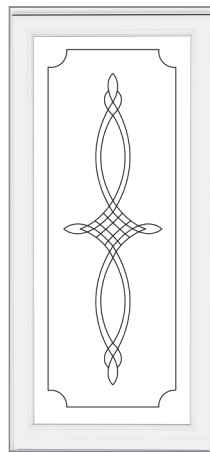

**Elegant Bevel Glass
149EBV**

FRAME COLORS



White



Almond



Sandstone





Brown



Black

LIST PRICE

MODEL	SIZE	WHITE	ALMOND	SANDSTONE	BROWN	BLACK
149FVE Low-E	32" x 81" 36" x 81"	\$419.00				\$441.00
149FV Clear	32" x 81" 36" x 81"	\$358.00				\$380.00
	30" x 81"	\$380.00				
	34" x 81"	\$358.00				
149PV Pet Door	32" x 81" 36" x 81"	\$552.00				\$573.00
149BV Arched Double Bevel	32" x 81" 36" x 81"	\$397.00				\$419.00
149EBV Elegant Bevel	36" x 81"	\$441.00				\$464.00
REGULAR CUSTOM** 						
149FVE Low-E	W: 24" - 36" H: 70" - 85"	\$727.00				\$750.00
149FV Clear		\$649.00				\$671.00
OVERSIZE CUSTOM** 						
149FVE Low-E	W: 36-1/8" - 42" H: 70" - 85"	\$873.00				\$895.00
149FV Clear		\$794.00				\$816.00
OVERSIZE PLUS CUSTOM**  Specify hinge side as viewed from outside.						
149FVE Low-E	W: 24" - 42" H: 85-1/8" - 97"	\$895.00				\$917.00
149FV Clear		\$816.00				\$839.00

QUICKFIT™ HANDLESETS

Sold separately and required to operate the built-in deadbolt on Platinum Collection, 149 Elegant Selection™ and 146 Easy Vent® Selection models. QuickFit handlesets cannot be modified for use with older models.

QUICKFIT HANDLESET	
SINGLE EA. \$60.00	3-PACK*** \$146.00
STRAIGHT 20298953 Matte Black 20298917 Brushed Nickel 20298957 Aged Bronze	
CURVED 20297817 Brushed Nickel 20297857 Aged Bronze 20297820 Antique Brass 20297807 Brass	

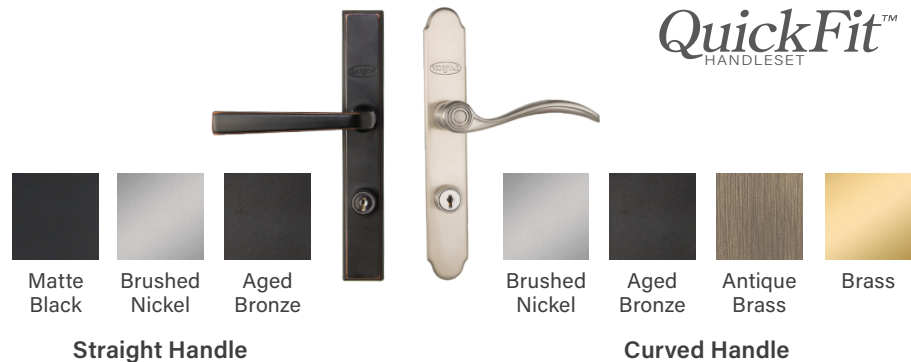

FRENCH DOOR KIT AVAILABLE

Refer to charts on pages 46–49. For French door configurations with a pet door, consider pairing one 149PV with a 149FVE or 149FV.

*The 149PV does not include an interchangeable screen.

**Custom doors have extended, variable lead times. Once placed, custom orders cannot be canceled.

***Order in increments of three (same finish) for reduced pricing.

Note: Larson reserves the right to alter or discontinue any model, specification, warranty or price without notice.

Product finish colors are approximate; actual finish colors may vary. See your Larson seller or visit larsondoors.com for details on limited warranties and exclusions.



Model Shown: 350-17
Brushed Nickel Handleset

350 Classic-View Fullview

TOP BENEFITS

- **Low-maintenance durability.** Constructed with 1-1/4" thick extruded aluminum and surrounded by a heavy-duty weatherstrip.
- **Seasonal ventilation, maximum light.** Interchangeable fullview glass and screen open the home to the best of each season, including fresh air in the summer and natural light in the winter.

ADDITIONAL FEATURES

- Adjustable-speed closer is color-matched to the door.
- Includes decorative lever handleset with a built-in deadbolt.
- The bottom expander helps seal the opening, even in entries with uneven sills.



LIFETIME WARRANTY



EASY LEFT- OR RIGHT-HINGE INSTALLATION

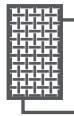

INTERCHANGEABLE SCREEN & GLASS

HANDLESET INCLUDED



Brushed Nickel



Brass

FRAME COLORS



White



Almond



Sandstone



Brown



Black

LIST PRICE

MODEL	SIZE	WHITE	ALMOND	SANDSTONE	BROWN	BLACK
350-17 Brushed Nickel 350-04 Brass	32" x 81" 36" x 81"			\$309.00		\$331.00
REGULAR CUSTOM*						
350-17, 350-04	W: 24" - 36" H: 70" - 85"			\$582.00		\$604.00
OVERSIZE CUSTOM*						
350-17, 350-04	W: 36-1/8" - 40" H: 70" - 85"			\$705.00		\$727.00
OVERSIZE PLUS CUSTOM* Specify hinge side as viewed from outside.						
350-17, 350-04	W: 24" - 40" H: 85-1/8" - 90"			\$738.00		\$760.00

FRENCH DOOR KIT AVAILABLE



Model Shown: 350-04
Brown Frame with Brass Handleset

*Custom doors have extended, variable lead times. Once placed, custom orders cannot be canceled.
Note: Larson reserves the right to alter or discontinue any model, specification, warranty or price without notice. Product finish colors are approximate; actual finish colors may vary. See your Larson seller or visit larsondoors.com for details on limited warranties and exclusions.

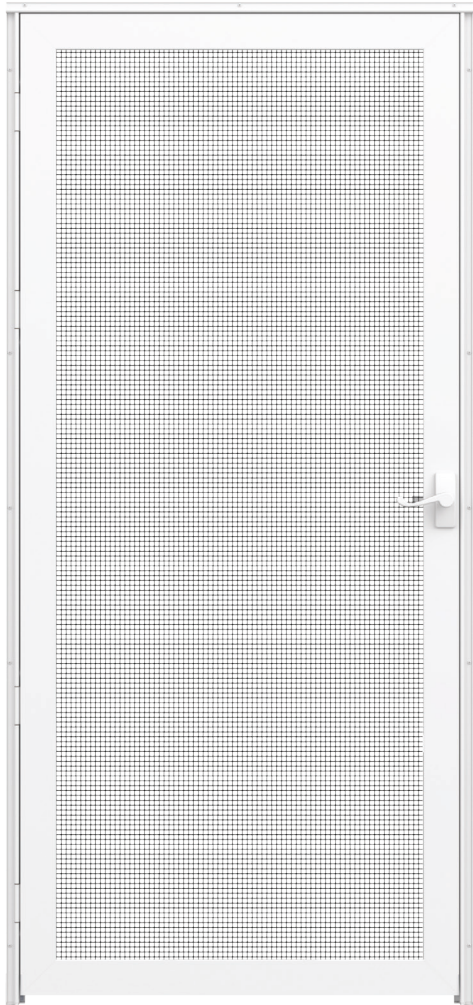

Model Shown: 360-48
WearTuff Screen

360-48 WearTuff® Full Screen

TOP BENEFITS

- **Fresh air without compromise.** The kid- and pet-friendly WearTuff® screen is reinforced in frame for durable ventilation. Screen upgrade options are available.
- **Low-maintenance durability.** Constructed with 1-1/4" thick extruded aluminum and surrounded by a heavy-duty weatherstrip.

ADDITIONAL FEATURES

- A weatherstrip on the mounting rail provides extra defense against airborne pests.
- Adjustable-speed closer is color-matched to the door.
- Includes color-matched lever handleset with an inside lock.
- The bottom expander helps seal the opening, even in entries with uneven sills.



LIFETIME
WARRANTY



EASY LEFT- OR RIGHT-
HINGE INSTALLATION

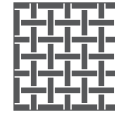

WEARTUFF
SCREEN



**HANDLESET
INCLUDED**

FRAME & HANDLESET COLORS



White



Brown

SCREEN OPTIONS

WearTuff®

Durable mesh screen holds up to wear and tear.

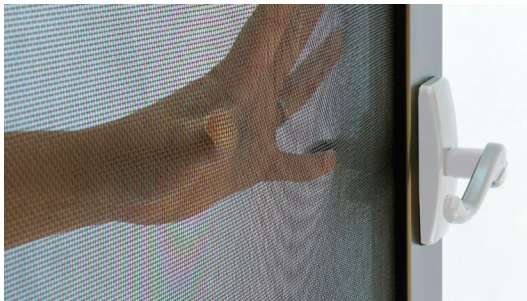

UPGRADE SCREEN OPTIONS

PetScreen®

Tear- and puncture-resistant screen built with your pet in mind.

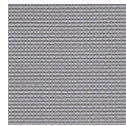

No-See-Um

Tight mesh guards against small insects.

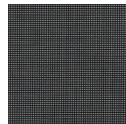

SunTex. 80

Provides approximately 75% UV blockage for shade and privacy.

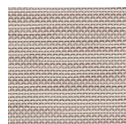

Stucco

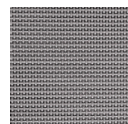

Gray

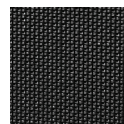

Black

LIST PRICE

		WEARTUFF		UPGRADE SCREEN OPTIONS PetScreen No-See-Um SunTex 80 Stucco SunTex 80 Gray SunTex 80 Black	
MODEL	SIZE	WHITE	BROWN	WHITE	BROWN
360-48	32" x 81" 36" x 81"	\$220.00		\$287.00	
REGULAR CUSTOM* ✂					
360-48	W: 24" - 36" H: 70" - 85"	\$347.00		\$420.00	
OVERSIZE CUSTOM* ✂					
360-48	W: 36-1/8" - 42" H: 70" - 85"	\$410.00			
OVERSIZE PLUS CUSTOM* ✂ Specify hinge side as viewed from outside.					
360-48	W: 24" - 42" H: 85-1/8" - 97"	\$461.00		\$500.00 (W: 24"-36")	

FRENCH DOOR KIT AVAILABLE

Refer to charts on pages 46-49.



Model Shown: 360-48
White Frame with WearTuff Screen

*Custom doors have extended, variable lead times. Once placed, custom orders cannot be canceled.
Note: Larson reserves the right to alter or discontinue any model, specification, warranty or price without notice. Product finish colors are approximate; actual finish colors may vary. See your Larson seller or visit larsondoors.com for details on limited warranties and exclusions. Not intended to keep children or pets inside.

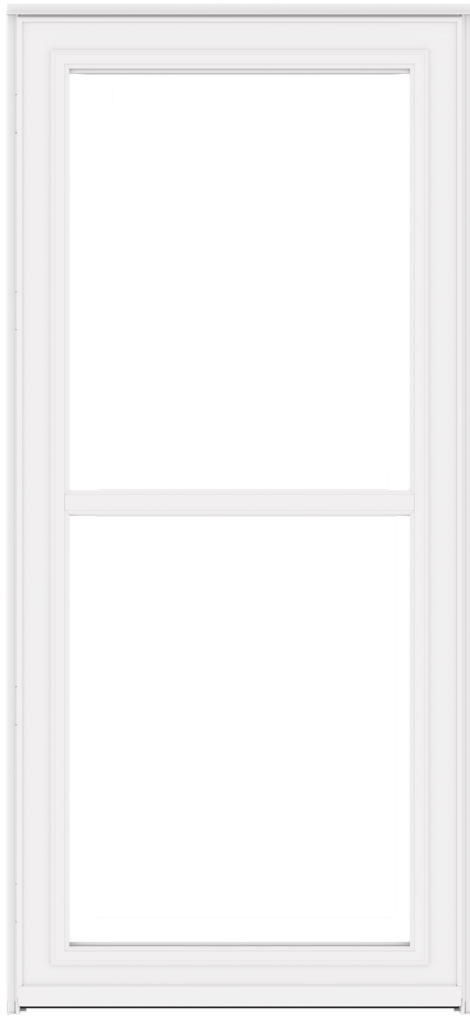

Model Shown: 146FVE | 146FV
Fullview with Low-E/Clear

146 Easy Vent® Selection

TOP BENEFITS

- **Enduring protection.** Constructed with heavy-duty, low-maintenance 1-7/8" thick extruded aluminum and surrounded by a dual weatherstrip for exceptional weather resistance.
- **Instant airflow with a view.** Screen Away® retractable screen disappears above the window for a clear view.
- **Steady convenience.** The two-closer system provides extra stability and features a hold-open button to keep the door open with the tap of a toe.

ADDITIONAL FEATURES

- An overlapping edge helps seal out the elements and delivers a streamlined look that conceals hinges and gaps.
- Balanced window system easily opens with one hand.
- **146PV** – Built-in 8" x 12" pet door fits pets up to 40 lbs. and includes a slide-in panel cover.
- Designer screw covers conceal exterior mounting screws.
- Includes self-drilling installation screws.
- The bottom expander seals the opening, even in entries with uneven sills.



LIFETIME
WARRANTY



EASY LEFT- OR RIGHT-
HINGE INSTALLATION



RETRACTABLE
SCREEN



UPGRADE TO
LOW-E GLASS

ADDITIONAL MODELS



Pet Door
146PV

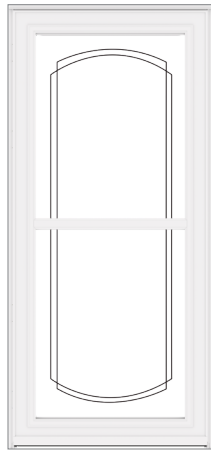

Bevel Glass
146BV



Midview
146MV

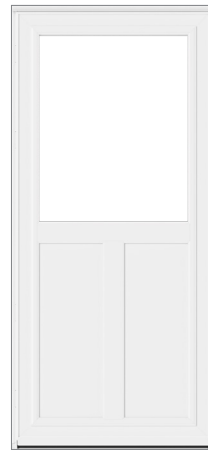

Highview
146HV

FRAME COLORS



White



Almond



Sandstone



Brown





Graphite



Black

LIST PRICE

MODEL	SIZE	WHITE	ALMOND	SANDSTONE	BROWN	GRAPHITE	BLACK
146FVE Low-E	32" x 81" 36" x 81"	\$507.00				\$530.00	
	34" x 81"	\$507.00					
146FV Clear	32" x 81" 36" x 81"	\$464.00				\$485.00	
	30" x 81"	\$485.00					
	34" x 81"	\$464.00		\$464.00		\$464.00	
146PV Pet Door	32" x 81" 36" x 81"	\$604.00					\$626.00
146BV Bevel	36" x 81"	\$530.00					\$563.00
146MV Midview	32" x 81" 36" x 81"	\$485.00					\$507.00
	34" x 81"	\$485.00		\$485.00		\$507.00	
146HV Highview	32" x 81" 36" x 81"	\$514.00					
REGULAR CUSTOM* 							
146FVE Low-E	W: 30" - 40" H: 70" - 86"	\$816.00				\$873.00	
146FV Clear		\$772.00				\$816.00	
OVERSIZE CUSTOM* 							
146FVE Low-E	W: 32" - 40" H: 86-1/8 - 97"	\$950.00				\$995.00	
146FV Clear		\$895.00				\$940.00	

QUICKFIT™ HANDLESETS

Sold separately and required to operate the built-in deadbolt on Platinum Collection, 149 Elegant Selection™ and 146 Easy Vent® Selection models. QuickFit handlesets cannot be modified for use with older models.

QUICKFIT HANDLESET	
SINGLE EA. \$60.00	3-PACK*** \$146.00
STRAIGHT 20298953 Matte Black 20298917 Brushed Nickel 20298957 Aged Bronze	
CURVED 20297817 Brushed Nickel 20297857 Aged Bronze 20297820 Antique Brass 20297807 Brass	

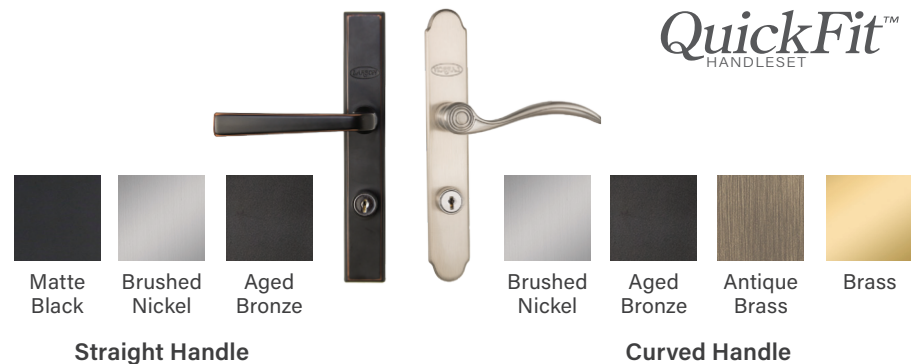

FRENCH DOOR KIT AVAILABLE

Refer to charts on pages 46–49. For French door configurations with a pet door, consider pairing one 146PV with a 146FVE or 146FV.

*Custom doors have extended, variable lead times. Once placed, custom orders cannot be canceled.

**Order in increments of three (same finish) for reduced pricing.

Note: Larson reserves the right to alter or discontinue any model, specification, warranty or price without notice. Product finish colors are approximate; actual finish colors may vary. See your Larson seller or visit larsondoors.com for details on limited warranties and exclusions.

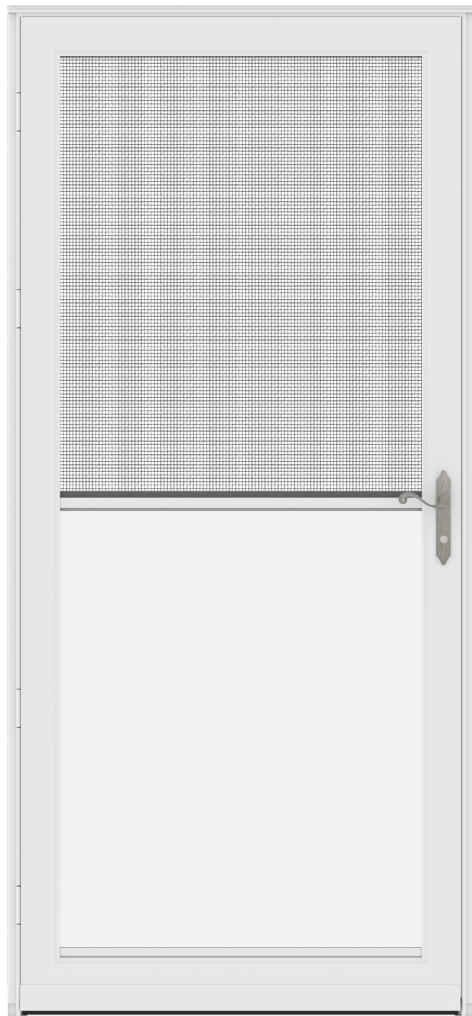

Model Shown: 356-52
Brushed Nickel Handleset

356 Lifestyle Fullview Screen Away®

TOP BENEFITS

- **Low-maintenance durability.** Constructed with 1-3/8" thick extruded aluminum and surrounded by a heavy-duty weatherstrip.
- **Instant airflow with a view.** Screen Away® retractable screen disappears above the window for a clear view.

ADDITIONAL FEATURES

- Adjustable-speed closer is color-matched to the door.
- Includes decorative lever handleset with color-matched interior and keyed lock.
- Designer screw covers conceal exterior mounting screws.
- The bottom expander seals the opening, even in entries with uneven sills.



LIFETIME
WARRANTY



EASY LEFT- OR RIGHT-
HINGE INSTALLATION



RETRACTABLE
SCREEN



HANDLESET INCLUDED



Brushed
Nickel



Brass

FRAME COLOR



White

LIST PRICE

MODEL	SIZE	WHITE
356-52 Brushed Nickel	32" x 81"	\$376.00
356-60 Brass	34" x 81"	
	36" x 81"	

*Custom doors have extended, variable lead times. Once placed, custom orders cannot be canceled.

Note: Larson reserves the right to alter or discontinue any model, specification, warranty or price without notice. Product finish colors are approximate; actual finish colors may vary. See your Larson seller or visit larsondoors.com for details on limited warranties and exclusions.



Model Shown: 830-82
Brushed Nickel Handleset

830 Lifestyle Midview Screen Away®

TOP BENEFITS

- **Seal out the elements.** High-performance composite surface and durable weatherstrip deliver weather-resistant protection that lasts.
- **Instant airflow with a view.** Screen Away® retractable screen disappears above the window for a clear view.

ADDITIONAL FEATURES

- Magnetic weatherstrip secures the door for a tight seal.
- Solid wood core provides durable insulation.
- Includes matching Secure Lock® handleset with an inside lock.
- Two adjustable-speed closers are color-matched to the door.
- The bottom expander seals the opening, even in entries with uneven sills.

10 YEAR
LIMITED WARRANTY

10-YEAR
WARRANTY



EASY LEFT- OR RIGHT-
HINGE INSTALLATION



RETRACTABLE
SCREEN

HANDLESET INCLUDED



Brushed
Nickel



Brass

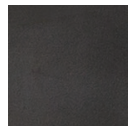

Aged
Bronze

FRAME COLORS



White



Almond



Sandstone



Brown

LIST PRICE

MODEL	SIZE	WHITE	ALMOND	SANDSTONE	BROWN
830-82 Brushed Nickel 830-80 Brass 830-85 Aged Bronze	32" x 81" 34" x 81" 36" x 81"	\$371.00			
REGULAR CUSTOM*					
830-82, 830-80, 830-85	W: 30" - 36" H: 67-1/2" - 85"	\$515.00			
OVERSIZE PLUS CUSTOM* Specify hinge side as viewed from outside.					
830-82, 830-80, 830-85	W: 36-1/8" - 42" H: 85-1/8" - 90"	\$637.00			\$637.00

CUSTOM DOORS

- Glass insert size remains standard; frame size adjusts for custom order.
- Maximum size: 42" x 90" uses same size glass insert as standard 36" x 81".
- Minimum size: 30" x 67-1/2" uses same size glass insert as 32" x 81" door.
- Moldings are NOT available on models with opening heights under 77-1/2".

FRENCH DOOR KIT AVAILABLE

Refer to charts on pages 46-49.



Model Shown: 370-84
White

NEW 370-84 Lifestyle 2.0 Midview Screen Away®

Available Q3 2024

TOP BENEFITS

- **Seal out the elements.** High-performance smooth composite surface and durable weatherstrip deliver weather-resistant protection that lasts.
- **Refreshed modern style.** Complement the modern style of your home or entry door with the sleek, minimalist design of the door surface, flat window frame and included handleset.
- **Install with confidence.** Our enhanced installation experience includes easy-to-follow instructions, step-by-step videos, live customer support and simplified component labeling – all tested by installation experts.

ADDITIONAL FEATURES

- Screen Away® retractable screen disappears above the window for a clear view.
- Solid wood core provides durable insulation.
- Includes matching Secure Lock® handleset with a keyed lock.
- Adjustable-speed closer with hold-open button keeps the door in place with the tap of a toe.
- The bottom expander seals the opening, even in entries with uneven sills.

10 YEAR
LIMITED WARRANTY

10-YEAR
WARRANTY



EASY LEFT- OR RIGHT-
HINGE INSTALLATION



RETRACTABLE
SCREEN



Brushed
Nickel

FRAME COLORS



White

Almond

Brown

LIST PRICE

MODEL	SIZE	WHITE	ALMOND	BROWN
370-84 Brushed Nickel	32" x 81" 36" x 81"	\$336.00	\$352.00	
	30" x 81" 34" x 81"	\$378.00		

FRENCH DOOR KIT AVAILABLE

Refer to charts on pages 46–49.



Model Shown: 691-55
Aged Bronze Handleset

691 Lifestyle Highview Screen Away®

TOP BENEFITS

- **Seal out the elements.** High-performance composite surface and durable weatherstrip deliver weather-resistant protection that lasts.
- **Instant airflow with a view.** Screen Away® retractable screen disappears above the window for a clear view.

ADDITIONAL FEATURES

- Magnetic weatherstrip secures the door for a tight seal.
- Solid wood core provides durable insulation.
- Includes matching Secure Lock® handleset with a keyed lock.
- Two adjustable-speed closers are color-matched to the door.
- The bottom expander seals the opening, even in entries with uneven sills.

10 YEAR
LIMITED WARRANTY

10-YEAR
WARRANTY



EASY LEFT- OR RIGHT-
HINGE INSTALLATION



RETRACTABLE
SCREEN

HANDLESET INCLUDED



Brushed
Nickel



Brass

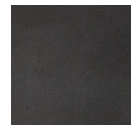

Aged
Bronze

FRAME COLORS



White



Sandstone



Brown

LIST PRICE

MODEL	SIZE	WHITE	SANDSTONE	BROWN
691-52 Brushed Nickel 691-55 Aged Bronze 691-90 Brass	32" x 81" 36" x 81"			\$391.00
REGULAR CUSTOM* Specify hinge side as viewed from outside if over 85".				
691-52, 691-55, 691-90	W: 29" - 36" H: 52" - 90"			\$526.00

CUSTOM DOORS

- Glass insert size remains standard; frame size adjusts for custom order.
- Maximum size: 36" x 90" uses same size glass insert as standard 36" x 81".
- Minimum size: 29" x 52" uses same size glass insert as 32" x 81" door.
- Moldings are NOT available on models with opening heights under 77-1/2".

FRENCH DOOR KIT AVAILABLE

Refer to charts on pages 46-49.

*Custom doors have extended, variable lead times. Once placed, custom orders cannot be canceled.
Note: Larson reserves the right to alter or discontinue any model, specification, warranty or price without notice. Product finish colors are approximate; actual finish colors may vary. See your Larson seller or visit larsondoors.com for details on limited warranties and exclusions.

360-79 Classic-View Pet View

TOP BENEFITS

- **Low-maintenance durability.** Constructed with 1-1/4" thick extruded aluminum and surrounded by a heavy-duty weatherstrip.
- **Convenience for you and your pet.** Built-in 10" x 17" pet door fits pets up to 100 lbs. and includes a slide-in panel cover.

ADDITIONAL FEATURES

- Tear-resistant WearTuff® screen provides durable ventilation.
- Built-in Reversa Screen offers top or bottom ventilation.
- Bottom glass lets your pet see outside.
- Includes color-matched lever handleset with an inside lock.
- Adjustable-speed closer is color-matched to the door.
- The bottom expander seals the opening, even in entries with uneven sills.

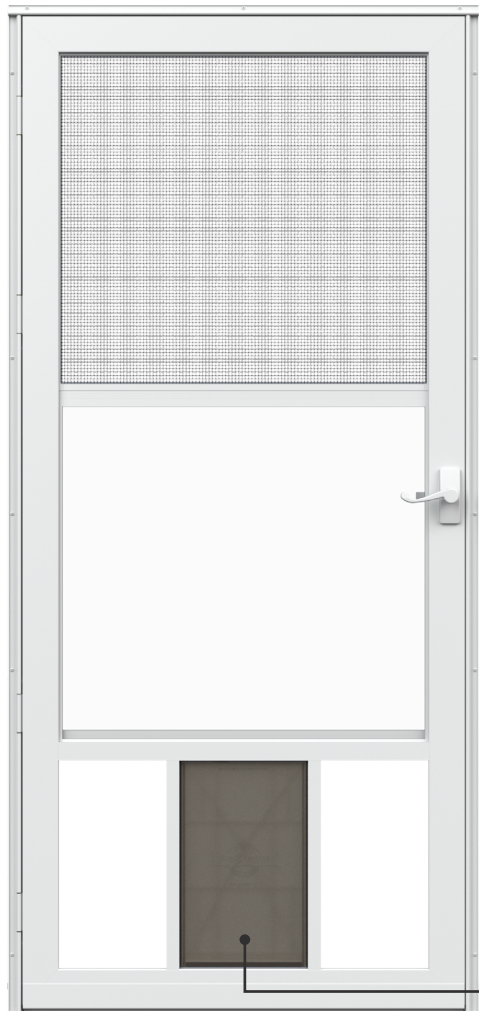

LIFETIME WARRANTY



EASY LEFT- OR RIGHT-HINGE INSTALLATION



REVERSA SCREEN

INCLUDES SLIDE-IN PANEL COVER TO SECURE PET FLAP.



HANDLESET INCLUDED

Model Shown: 360-79
 Flap Opening: 10" x 17"
 White Handleset

LIST PRICE

MODEL	SIZE	WHITE	BROWN
360-79	32" x 81" 36" x 81"	\$441.00	

FRAME & HANDLESET COLORS

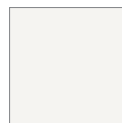

White



Brown

360-49 Pet Breeze

TOP BENEFITS

- **Low-maintenance durability.** Constructed with 1-1/4" thick extruded aluminum and surrounded by a heavy-duty weatherstrip.
- **Convenience for you and your pet.** Built-in 10" x 17" pet door fits pets up to 100 lbs. and includes a slide-in panel cover.

ADDITIONAL FEATURES

- Tear- and puncture-resistant PetScreen® is built to withstand daily wear and tear from pets.
- Includes color-matched lever handleset with an inside lock.
- Adjustable-speed closer is color-matched to the door.
- The bottom expander seals the opening, even in entries with uneven sills.

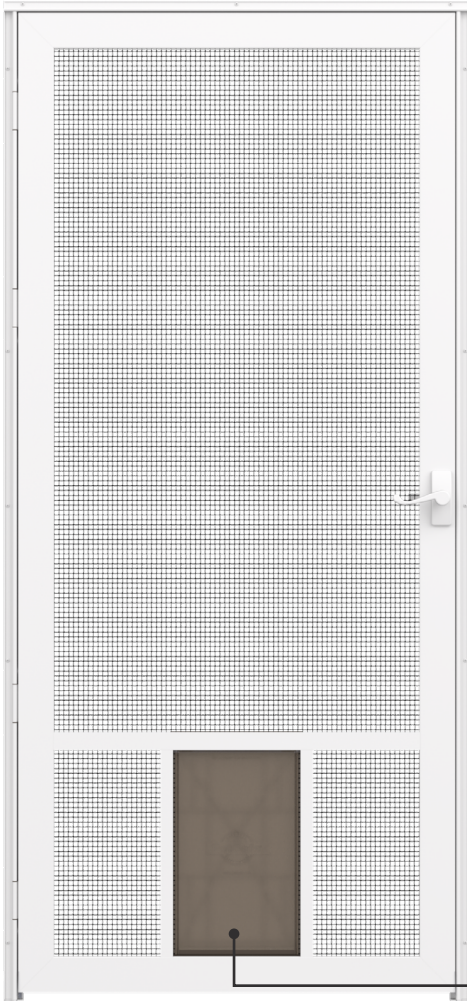

LIFETIME WARRANTY



EASY LEFT- OR RIGHT-HINGE INSTALLATION

INCLUDES SLIDE-IN PANEL COVER TO SECURE PET FLAP.



Model Shown: 360-49
Flap Opening: 10" x 17"
White Handleset



HANDLESET INCLUDED

LIST PRICE

MODEL	SIZE	WHITE	BROWN
360-49	32" x 81" 36" x 81"	\$314.00	

FRAME & HANDLESET COLORS



White



Brown

FRENCH DOOR KIT AVAILABLE

Refer to charts on pages 46–49.

370 Life-Core® Pet Single-Vent

TOP BENEFITS

- **Seal out the elements.** High-performance composite surface and durable weatherstrip deliver weather-resistant protection that lasts.
- **Convenience for you and your pet.** Built-in pet door lets pets come and go as they please and includes a slide-in panel cover.

ADDITIONAL FEATURES

- **370-79** – Built-in 10" x 17" pet door fits pets up to 100 lbs.
- **370-78** – Built-in 14" x 23" pet door fits pets up to 220 lbs.
- Solid wood core provides durable insulation.
- Single-vent screen for bottom ventilation.
- Includes matching Secure Lock® handleset with an inside lock.
- Adjustable-speed closer is color-matched to the door.
- The bottom expander seals the opening, even in entries with uneven sills.

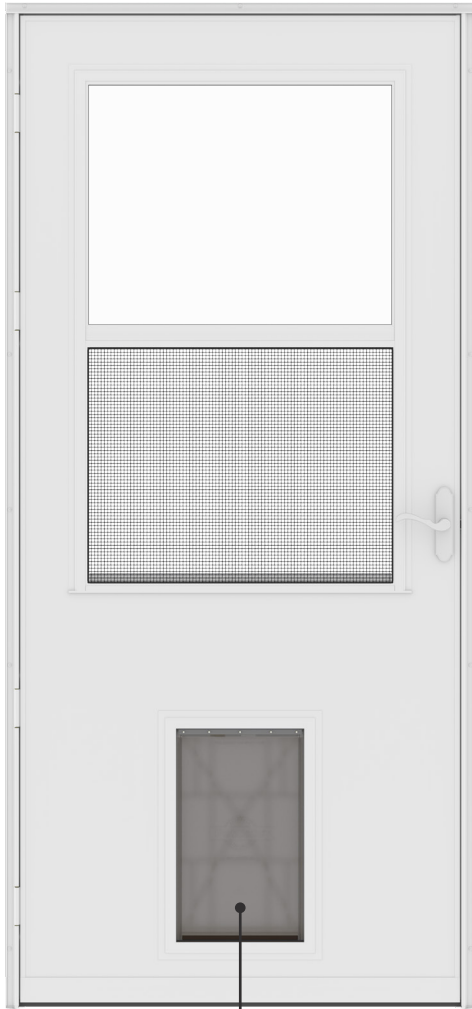

Model Shown: 370-79
 Flap Opening: 10" x 17"
 White Handleset



10-YEAR WARRANTY



EASY LEFT- OR RIGHT-HINGE INSTALLATION



SINGLE VENT

INCLUDES SLIDE-IN PANEL COVER TO SECURE PET FLAP.

ADDITIONAL MODEL



Flap Opening:
 14" x 23"
370-78



HANDLESET INCLUDED

FRAME & HANDLESET COLORS





White



Almond

LIST PRICE

MODEL	SIZE	WHITE	ALMOND
370-79 10" x 17" Pet Door	32" x 81" 36" x 81"	\$386.00	
370-78 14" x 23" Pet Door		\$441.00	
REGULAR CUSTOM* 			
370-79 10" x 17" Pet Door	W: 28" - 36" H: 71-1/2" - 85"	\$582.00	
370-78 14" x 23" Pet Door	W: 28" - 36" H: 81" - 85"	\$637.00	
REGULAR CUSTOM*  Specify hinge side as viewed from outside.			
370-79 10" x 17" Pet Door	W: 36-1/8" - 42" H: 85-1/8" - 96"	\$683.00	
370-78 14" x 23" Pet Door		\$750.00	

CUSTOM DOORS

- Pet door remains the same size on all custom doors.
- Glass insert size remains standard; frame size adjusts for custom order.
- Maximum size: 42" x 96" uses same size glass insert as standard 36" x 81".
- Minimum size: 28" x 71-1/2" uses same size glass insert as 32" x 81" door.

FRENCH DOOR KIT AVAILABLE

Refer to charts on pages 46-49. For French door configurations with a pet door, consider pairing one 370-79 with a 278-SS.



Model Shown: 370-79
White Frame with 10" x 17" Pet Flap

*Custom doors have extended, variable lead times. Once placed, custom orders cannot be canceled.
Note: Larson reserves the right to alter or discontinue any model, specification, warranty or price without notice. Product finish colors are approximate; actual finish colors may vary. See your Larson seller or visit larsondoors.com for details on limited warranties and exclusions.



Model Shown: 370-50
White

370-50 Life-Core® Reversa Screen

TOP BENEFITS

- **Seal out the elements.** High-performance composite surface and durable weatherstrip deliver weather-resistant protection that lasts.
- **Flexible ventilation.** Built-in Reversa Screen offers top or bottom ventilation.

ADDITIONAL FEATURES

- Tear-resistant WearTuff® screen provides durable ventilation.
- Solid wood core provides durable insulation.
- Includes a strong-hold handleset with a keyed lock.
- FlexGuard™ closer opens door past 90-degrees.
- The bottom expander seals the opening, even in entries with uneven sills.
- Multi-hinge system delivers extra durability in high-traffic areas.



10-YEAR
WARRANTY



EASY LEFT- OR RIGHT-
HINGE INSTALLATION



REVERSA
SCREEN

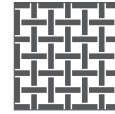

WEARTUFF
SCREEN



**HANDLESET
INCLUDED**

**FRAME & HANDLESET
COLORS**



White



Brown

LIST PRICE

MODEL	SIZE	WHITE	BROWN
370-50	32" x 81" 34" x 81" 36" x 81"	\$259.00	
	30" x 81"	\$274.00	

FRENCH DOOR KIT AVAILABLE

Refer to charts on pages 46-49.

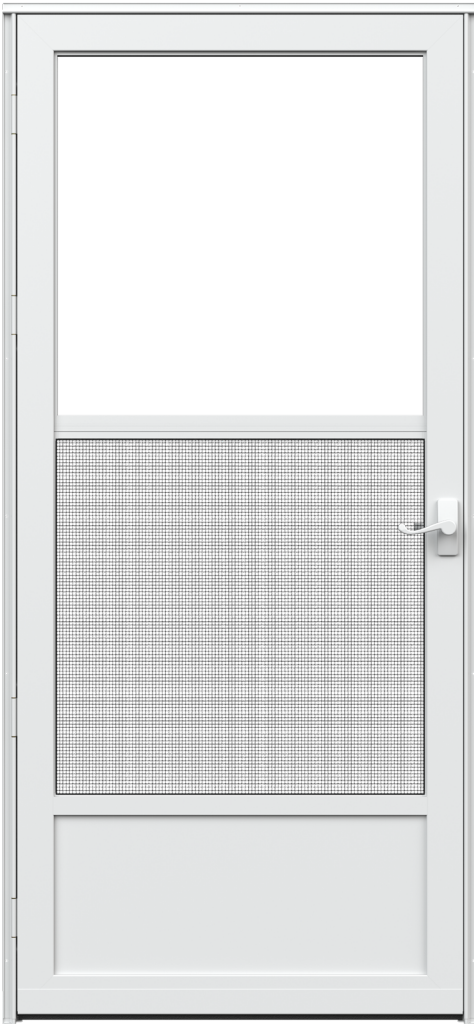

360-16 / 660-16 Classic-View Reversa Screen

TOP BENEFITS

- **Low-maintenance durability.** Constructed with 1-1/4" thick extruded aluminum and surrounded by a heavy-duty weatherstrip.
- **Flexible ventilation.** Built-in Reversa Screen offers top or bottom ventilation.

ADDITIONAL FEATURES

- Rigid steel kick panel stands up to heavy use.
- Includes color-matched lever handleset with an inside lock.
- Adjustable-speed closer is color-matched to the door.
- The bottom expander seals the opening, even in entries with uneven sills.



LIFETIME WARRANTY



EASY LEFT- OR RIGHT-HINGE INSTALLATION



REVERSA SCREEN



HANDLESET INCLUDED

FRAME & HANDLESET COLORS



White



Brown

Model Shown: 360-16/660-16
White

LIST PRICE

MODEL	SIZE	WHITE	BROWN
360-16 (660-16)	32" x 81" 36" x 81"	\$280.00	
	34" x 81"	\$280.00	
	30" x 81"	\$294.00	

FRENCH DOOR KIT AVAILABLE

Refer to charts on pages 46–49.



278-SS Life-Core® Single-Vent

TOP BENEFITS

- **Seal out the elements.** High-performance composite surface and durable weatherstrip deliver weather-resistant protection that lasts.
- **Open to fresh air.** Built-in single-vent screen provides convenient bottom ventilation.

ADDITIONAL FEATURES

- Solid wood core provides durable insulation.
- Includes matching Secure Lock® handleset with an interior lock.
- Adjustable-speed closer is color-matched to the door.
- The bottom expander seals the opening, even in entries with uneven sills.



10-YEAR
WARRANTY



EASY LEFT- OR RIGHT-
HINGE INSTALLATION



SINGLE
VENT



**HANDLESET
INCLUDED**

FRAME & HANDLESET COLORS



White



Almond



Sandstone



Brown

Model Shown: 278-SS
White

LIST PRICE

MODEL	SIZE	WHITE	ALMOND	SANDSTONE	BROWN
278-SS	32" x 81" 36" x 81"	\$298.00			
	30" x 81" 34" x 81"	\$314.00			
	32" x 85" 36" x 85"	\$333.00			
REGULAR CUSTOM*					
278-SS	W: 28" - 36" H: 52" - 85"	\$414.00			
OVERSIZE CUSTOM*					
278-SS	W: 36-1/8" - 42" H: 52" - 85"	\$492.00			\$492.00
OVERSIZE PLUS CUSTOM* Specify hinge side as viewed from outside.					
278-SS	W: 32" - 42" H: 85-1/8" - 96"	\$548.00			\$548.00

CUSTOM DOORS

- **Oversize custom:** Any dimension larger than 36" wide or 85" high.
- **Maximum size:** 42" x 85" uses same size glass insert as standard 36" x 81".
- **Minimum size:** 28" x 52" uses same size glass insert as standard 32" x 81".
- **SPECIAL STANDARD** 32" x 85", 36" x 85" and custom doors over 85" high use a taller glass insert. Standard glass frame sizes are used for all custom doors. The door frame adjusts to fit the custom dimensions.

FRENCH DOOR KIT AVAILABLE

Refer to charts on pages 46-49.



380-05 Mobile Home Single-Vent

TOP BENEFITS

- **Seal out the elements.** High-performance composite surface and durable weatherstrip deliver weather-resistant protection that lasts.
- **Open to fresh air.** Built-in single-vent screen provides convenient bottom ventilation.

ADDITIONAL FEATURES

- Solid wood core provides durable insulation.
- Includes stylish push button handleset.
- Adjustable-speed closer is color-matched to the door.
- The bottom expander seals the opening, even in entries with uneven sills.



10-YEAR
WARRANTY



EASY LEFT- OR RIGHT-
HINGE INSTALLATION



SINGLE
VENT



**HANDLESET
INCLUDED**

FRAME & HANDLESET COLORS



White

LIST PRICE

MODEL	SIZE	WHITE
380-05	30" x 75"	\$300.00
	32" x 75"	
	30" x 74"	\$327.00
	30" x 76"	
	32" x 74"	
	32" x 76"	
	32" x 78"	
	34" x 78"	
	36" x 74"	
	36" x 78"	

FRENCH DOOR KIT AVAILABLE

Refer to charts on pages 46–49.

*Custom doors have extended, variable lead times. Once placed, custom orders cannot be canceled.
 Note: Larson reserves the right to alter or discontinue any model, specification, warranty or price without notice. Product finish colors are approximate; actual finish colors may vary. See your Larson seller or visit larsondoors.com for details on limited warranties and exclusions.

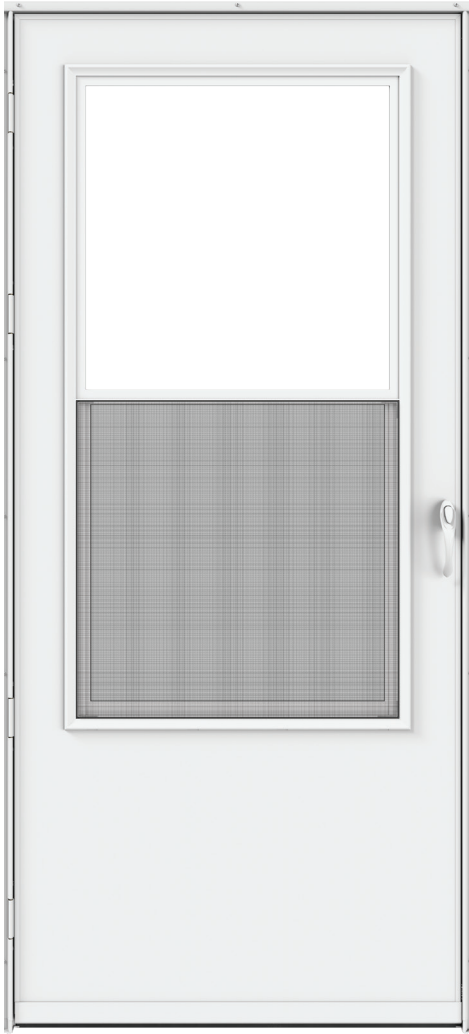

Model Shown: 298-SS
White

ENHANCED 298-SS Life-Core® Composite Surface Single-Vent

TOP BENEFITS

- **Seal out the elements.** High-performance composite surface and durable weatherstrip deliver weather-resistant protection that lasts.
- **Open to fresh air.** The ergonomic finger tabs on the built-in screen are elevated for an easy, pinch-free grip.
- **Install with confidence.** Our enhanced installation experience includes easy-to-follow instructions, step-by-step videos, live customer support and simplified component labeling – all tested by installation experts.

ADDITIONAL FEATURES

- Solid wood core provides durable insulation.
- Single-vent screen provides convenient bottom ventilation.
- Includes a stylish handleset that complements the door color.*
- Adjustable-speed closer complements the door color.*
- The bottom expander seals the opening, even in entries with uneven sills.



10-YEAR
WARRANTY



EASY LEFT- OR RIGHT-
HINGE INSTALLATION



SINGLE
VENT



**HANDLESET
INCLUDED***

LIST PRICE

MODEL	SIZE	WHITE	BROWN
298-SS	32" x 81" 34" x 81" 36" x 81"	\$212.00	
	30" x 81"	\$226.00	

FRAME COLORS

Handleset will complement the frame color.*

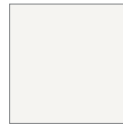

White



Brown

FRENCH DOOR KIT AVAILABLE

Refer to charts on pages 46–49.



Model Shown: 298-SS
White Frame

*White model comes with color-matched handle and closer. Brown model comes with black handle and closer.
Note: Larson reserves the right to alter or discontinue any model, specification, warranty or price without notice.
Product finish colors are approximate; actual finish colors may vary. See your Larson seller or visit larsondoors.com for details on limited warranties and exclusions.

Measuring Guide:

STORM DOORS

Use the diagram below to record your measurements as shown. If the width measurements vary, record the smallest measurement. **For Platinum Collection installation, please see page 18.**

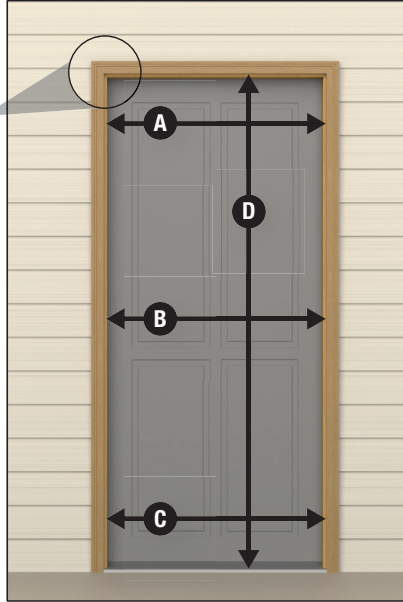
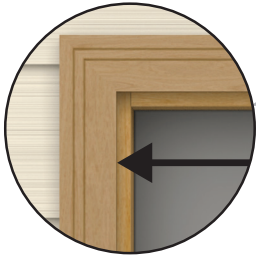

RECORD MEASUREMENTS

A	Width
B	Width
C	Width
D	Height



RECESS MOUNT

The rails mount inside the opening and require a 1" wide by 1" deep mounting surface.

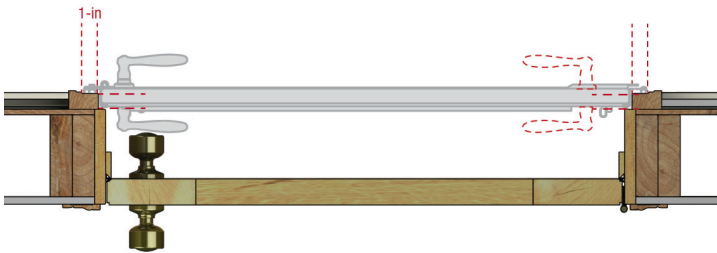

Construction styles may vary.

UNIVERSAL HINGING

Allows for left-hinge or right-hinge installation.

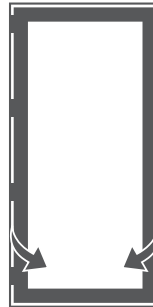

SPECIFY WHEN ORDERING:

- A.** Model Number
- B.** Color
- C.** Required Opening Size (Width x Height)
- D.** EasyHang® Universal Hinge

DOOR OPENING	MIN. WIDTH	MAX. WIDTH	MIN. HEIGHT	MAX. HEIGHT
30" x 81"	29-7/8"	30-3/8"	80"	81"
32" x 81"	31-7/8"	32-3/8"		
34" x 81"	33-7/8"	34-3/8"		
36" x 81"	35-7/8"	36-3/8"	84"	85"
32" x 85"	31-7/8"	32-3/8"		
34" x 85"	33-7/8"	34-3/8"		
36" x 85"	35-7/8"	36-3/8"	74-1/2"	75-1/2"
32" x 75"	31-7/8"	32-3/8"		
30" x 75"	29-7/8"	30-3/8"		



Model Shown: 146FV
Almond Frame with Curved Antique
Bronze QuickFit Handleset

French Door Opening Size Availability

NOMINAL SIZE (Width of Two Standard Doors)	FITS OPENING WIDTH:		FITS OPENING HEIGHT:	
	MINIMUM	MAXIMUM	MINIMUM	MAXIMUM
Wood Core Storm Door Conversion Kit				
32" (2'8" and 2'8")	63-1/2"	64-1/8"	80"	81"
36" (3'0" and 3'0")	71-1/2"	72-1/8"		
30" (2'6" and 2'6")	59-1/2"	60-1/8"		
34" (2'10" and 2'10")	67-1/2"	68-1/8"		
Classic-View Combination Door Conversion Kit				
32" (2'8" and 2'8")	63-1/2"	64-1/8"	80"	81"
36" (3'0" and 3'0")	71-1/2"	72-1/8"		
Easy Vent Selection 146 Series Combination Door Conversion Kit				
32" (2'8" and 2'8")	63-3/4"	64"	80"	81"
36" (3'0" and 3'0")	71-3/4"	72"		
34" (2'10" and 2'10")	67-3/4"	68"		
Elegant Selection 149 Series Combination Door Conversion Kit				
32" (2'8" and 2'8")	64"	64-1/4"	80"	81"
36" (3'0" and 3'0")	72"	72-1/4"		
30" (2'6" and 2'6")	60"	60-1/4"		
34" (2'10" and 2'10")	68"	68-1/4"		

LIST PRICE

MODEL	FINISH	PART #	LIST PRICE
Non-Keyed Mirrored Handles* 830-80, 830-82, 691-55, 691-52, 691-90, 278-SS, 370-78, 370-79	White	20266003	\$47.00
	Almond	20266008	
	Sandstone	20266009	
	Brown	20266004	\$55.00
	Brass	20266007	
	Brushed Nickel	20266017	
	Aged Bronze	20266057	

French Door Conversion Kits

Order by part number.

LIST PRICE

		PART NUMBER:							
MODEL	SIZE	WHITE	ALMOND	SANDSTONE	BROWN	GRAPHITE	BLACK	LIST PRICE	
Elegant Selection 149FVE 149FV 149BV 149EBV 149PV	60" x 80"	08007033RF							\$128.00
	64" x 80"	08007031RF	08007081RF	08007091RF	08007041RF		08007051RF		
	68" x 80"	08007035RF							
	72" x 80"	08007032RF	08007082RF	08007092RF	08007042RF		08007052RF		
149FVE 149FV	Custom Sizes**	Included in door product ID.					Included in door product ID.	\$154.00	
1-1/4" Thick 350-04 350-17	64" x 80"	08020361RF	08020861RF	08020961RF	08020461RF		08020561RF	\$128.00	
	72" x 80"	08020362RF	08020862RF	08020962RF	08020462RF		08020562RF		
350-04 350-17	Custom Sizes**	Included in door product ID.					Included in door product ID.	\$154.00	
Easy Vent Selection 146FVE 146MV 146FV 146HV 146BV 146PV	60" x 80"	080031033RF							\$128.00
	64" x 80"	080031031RF	080031081RF	080031091RF	080031041RF	080031391RF	080031051RF		
	68" x 80"	080031035RF		080031095RF					
	72" x 80"	080031032RF	080031082RF	080031092RF	080031042RF	080031392RF	080031052RF		
146FVE 146FV	Custom Sizes**	Included in door product ID.					Included in door product ID.	\$154.00	
Classic-View 360-16 660-16 360-48	60"x80"	080103033RF			080103043RF			\$105.00	
	64"x80"	080103031RF		080103091RF	080103041RF				
	68"x80"	080103035RF							
	72"x80"	080103032RF		080103092RF	080103042RF				
360-48	Custom Sizes**	Included in door product ID.			Included in door product ID.			\$128.00	
Lifestyle* 830-80 830-82 830-85 691-52 691-90 691-55	64"x80"	08003061RF	08008061RF	08009061RF	08004061RF			\$105.00	
	72"x80"	08003062RF	08008062RF	08009062RF	08004062RF				
830-80 830-82 830-85 691-52 691-90 691-55	Custom Sizes**	Included in door product ID.						\$128.00	

*Accepts mirrored handlesets. Must be ordered separately; includes shipping fee (refer to page 46).

**Custom sizes: Specify hinge side of main operating door as viewed from the outside.

Note: Larson reserves the right to alter or discontinue any model, specification, warranty or price without notice. Product finish colors are approximate; actual finish colors may vary.

French Door Conversion Kits *continued*

Order by part number.

LIST PRICE

MODEL	SIZE	PART NUMBER:				LIST PRICE
		WHITE	ALMOND	SANDSTONE	BROWN	
Life-Core* 278-SS 370-79 370-78 LifeStyle 370-84**	60"x80"	08003053RF				\$105.00
	64"x80"	08003051RF	08008051RF	08009051RF	08004051RF	
	72"x80"	08003052RF	08008052RF	08009052RF	08004052RF	
	64"x85"	08003054RF				
	68"x80"	08003055RF	08008055RF	08009055RF	08004055RF	
	72"x85"	08003057RF				
	Custom Sizes***	Included in door product ID.				
298-SS 370-50	60"x80"	08003003RF	08008003RF		08004003RF	\$105.00
	64"x80"	08003001RF	08008001RF		08004001RF	
	68"x80"	08003005RF			08004005RF	
	72"x80"	08003002RF	08008002RF		08004002RF	
380-05	60"x74" 60"x75" 60"x76"	08003003RF				\$105.00
	64"x74" 64"x75" 64"x76" 64"x78"	08003001RF				
	68"x78"	08003005RF				
	72"x74" 72"x78"	08003002RF				

*Accepts mirrored handlesets. Must be ordered separately; includes shipping fee (refer to page 46).

**370-84 is not available in Sandstone or custom sizes.

***Custom sizes: Specify hinge side of main operating door as viewed from the outside.

Note: Larson reserves the right to alter or discontinue any model, specification, warranty or price without notice. Product finish colors are approximate; actual finish colors may vary.

Measuring Guide:

EXISTING FRENCH DOOR OPENING

1. Measure full width of opening from jamb exterior trim where storm doors will attach to the trim.
2. Measure full height of opening from head exterior trim to threshold where storm doors will attach.
3. Compare your dimensions with the standard French storm door opening size guide. If your opening does not match a standard, you need custom French doors.

Note: Continuous wood shims up to 1/4" thick can be installed behind both hinge mounting rails, allowing a given width of standard doors to fit an opening 1/2" wider. Extra long screws will be needed to secure.

1 Front View

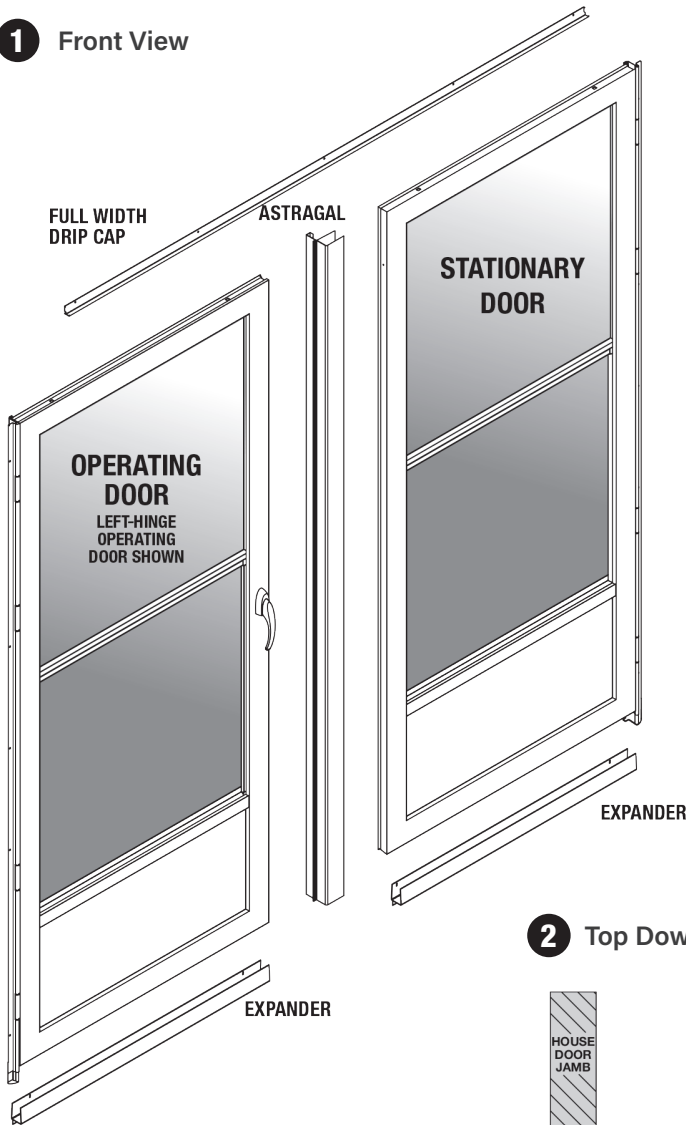

With a French door installation, you will have one left-hinge door and one right-hinge door. The astragal included in your French door kit replaces the latch side mounting rail included with each door. The full width drip cap included in the French door kit replaces the top drip caps included with the doors.

See pages 46–48 for size range per series.

ORDERING FRENCH DOOR UNITS

Standard Sizes: Order two standard size doors and a standard size French door kit.

Custom Sizes: Measure the true opening size of the entry and order the doors as **one** custom French door configuration with that measurement in inches. (For example, 73" x 84") Use the same measurement to order a French door kit separately.

TYPICAL LARSON® STORM DOOR FRENCH DOOR INSTALLATION

Kit parts, instructions and astragal vary by model.

2 Top Down View

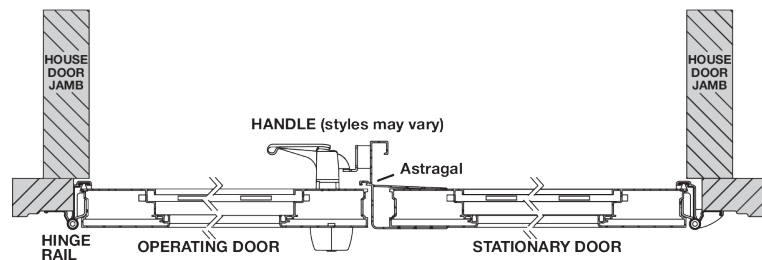

FRENCH DOOR KIT

With our French door conversion kits, Larson storm doors are easily adapted for double door entry applications. Each kit includes detailed installation instructions, all necessary hardware, astragal and special drip cap. Refer to French door size guide for proper selection of French door conversion kits. **Inactive handleset available on select models (sold separately).**

Retractable Screen Products

SCREENS FOR YOUR WHOLE HOME

Larson® screen products are designed to fit most existing door or window applications for the patio, lanai, garage, gazebo and front door. In addition to providing instant ventilation, retractable screens offer protection from airborne pests and harsh UV rays.

RETRACTABLE SCREEN BENEFITS

Choose from a complete line of screens which includes options for single door openings as well as large openings up to 315" (26') wide. Available in trending colors and styles to complement your home.

- Protection from airborne, biting pests.
- Easy to install and operate.
- Smooth operation with controlled retraction.
- Supports fresh, natural ventilation.

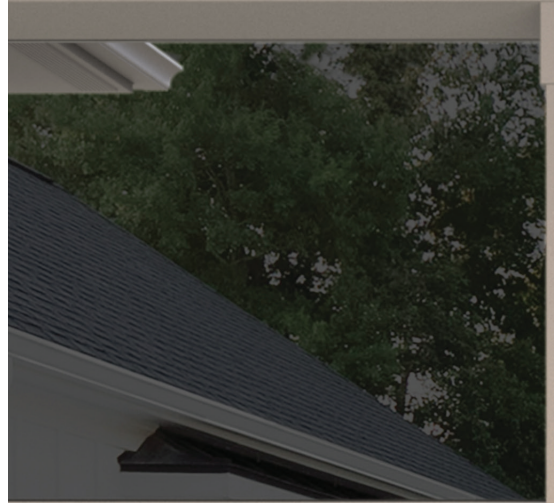

Model Shown: 9+
Retractable Motorized Screen
TuffScreen No-See-Ums in Black



Find the Right Screen

Use this guide to find Larson® retractable screens that fit your opening and meet your overall needs. Once you have narrowed down your selection, go to each product's page for complete details.

OPENING TYPE	MODEL	SIZING	INSTALLATION TYPE	
RETRACTABLE SCREEN DOOR - SINGLE & DOUBLE				
Single Hinged Door	Brisa 7721	Standard Sizes: Fits most traditional 6'6", 6'8" and 8'0" high entries up to 36" wide.	Surface/Face Mount	
Single Hinged Door	Escape E100	Custom Sizes: Up to 60"w x 96"h.	Surface/Face Mount Recess/Inset Mount	
Single Hinged Door	Inspire	Custom Sizes: Up to 63"w x 125"h.	Recess/Inset Mount	
Double Hinged Doors	Brisa 7722	Standard Sizes: Fits most traditional 6'6", 6'8" and 8'0" high entries up to 72" wide.	Surface/Face Mount	
Double Hinged Doors	Escape E200	Custom Sizes: Up to 96"w x 96"h.	Surface/Face Mount Recess/Inset Mount	
Double Hinged Doors	Inspire	Custom Sizes: Up to 126"w x 125"h.	Recess/Inset Mount	
Sliding Patio Door**	Brisa 7723**	Standard Size: Fits most 6'8" high XO or OX sliding patio doors.	Surface/Face Mount	
RETRACTABLE SCREEN DOOR - MULTI-PANEL				
Multi-Panel Doors	Wall Screen WS1000	Custom Sizes: Up to 177"w x 118"h. Maximum opening size of 114-3/5 sq. ft.	Recess/Inset Mount	
Multi-Panel Doors	Wall Screen WS2000	Custom Sizes: Up to 315"w x 118"h. Maximum opening size of 229-1/5 sq. ft.	Recess/Inset Mount	
Multi-Panel Doors	Inspire	Custom Sizes: Up to 378"w x 125"h.	Recess/Inset Mount	
RETRACTABLE WINDOW				
Casement, Awning Slider & Others	NatureVue NV100	Custom Sizes: 76"w x 92-1/4"h.	Surface/Face Mount Recess/Inset Mount	
RETRACTABLE MOTORIZED SCREEN				
Porch, Patio, Gazebo, Outdoor Living Area	Retractable Motorized Screen 6+, 7+, 8+, 9+, 10+	Custom Sizes: Up to 240"w x 144"h, depending on screen type.	Surface/Face Mount Recess/Inset Mount	

	FABRIC TYPE	FEATURES
	Smooth	EZ-Glide System ■ 30-Minute Install* ■ Mechanical Latch & Lock
	Smooth	Slam-Proof Retraction ■ Worry-Free Ventilation ■ Magnetic Latch
	Pleated	Flat Bottom Guide ■ Anywhere Positioning ■ Magnetic Latch
	Smooth	EZ-Glide System ■ 30-Minute Install* ■ Mechanical Latch & Lock
	Smooth	Slam-Proof Retraction ■ Worry-Free Ventilation ■ Magnetic Latch
	Pleated	Flat Bottom Guide ■ Anywhere Positioning ■ Magnetic Latch
	Smooth	EZ-Glide System ■ 30-Minute Install* ■ Mechanical Latch & Lock
	Pleated	One-hand operation ■ Anywhere Positioning ■ Mechanical Latch
	Pleated	One-hand operation ■ Anywhere Positioning ■ Mechanical Latch
	Pleated	Flat Bottom Guide ■ Anywhere Positioning ■ Magnetic Latch
	Smooth	Controlled Retraction ■ Thick Insect Pile ■ Metal Handle
	Smooth	Remote and Automated Operation ■ Insect, Solar and Privacy, and Vinyl Options ■ Durable Construction

*Based on average DIY skills and standard door application, widths 32"-36" (single), 68"-72" (double).

**Brisa Slider is the recommended way to screen most standard 6'8" high XO or OX sliding patio doors. For other heights or widths, the Escape 100 can be used. Special instructions are available to help guide the user before measuring, ordering and installing the Escape screen on a sliding patio door.



Model Shown: 7721
Single Brisa Screen

Brisa Retractable Screen Door

7721 (Single) 7722 (Double) 7723 (Slider)

A FRESH APPROACH TO FRESH AIR

Open your home to a new world of fresh air and light with the Brisa retractable screen door that pairs smart, contemporary design with smooth operation.

TOP BENEFITS

- **Worry-free ventilation.** Screen provides bug-free air when you need it and retracts out of sight when you don't.
- **Smooth operation.** The EZ-Glide System and ergonomic handle work together for easy, one-hand operation.

ADDITIONAL FEATURES

- Durable rust-resistant aluminum housing and track provide long-term reliability.
- Subtle stripes prevent walk-throughs.
- Quick-snap track requires no cutting for standard size openings.
- Surface mount installation for right- or left-hand operation in 30-minutes.*



LIFETIME
WARRANTY



EASY
INSTALL*

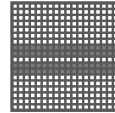

SUBTLE
STRIPES

FRAME COLORS



White



Sandstone



Brown



Black

CONFIGURATIONS

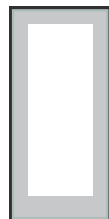

7721 - Single

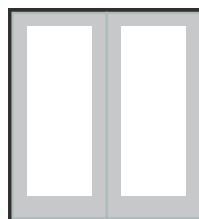

7722 - Double

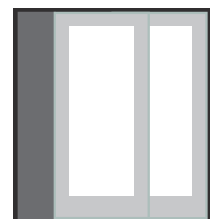

7723 - Slider

LIST PRICE

BRISA - SINGLE PACK							
MODEL		OPENING WIDTH	OPENING HEIGHT	WHITE	SANDSTONE	BROWN	BLACK
Brisa 7721** Single Door	Short	32" - 36"	78"-79" (e.g. 6'6" doors)	\$275.00			
	Standard	32" - 36"	80"-81" (e.g. 6'8" doors)	\$275.00			
	Tall	32" - 36"	96"-97" (e.g. 8'0" doors)	\$318.00			
Brisa 7722** Double Door	Short	68" - 72"	78"-79" (e.g. 6'6" doors)	\$424.00			
	Standard	68" - 72"	80"-81" (e.g. 6'8" doors)	\$424.00			
	Tall	68" - 72"	96"-97" (e.g. 8'0" doors)	\$467.00			
Brisa 7723*** Sliding Door	Standard	32" - 36"	78"-79" (e.g. 6'6" doors)	\$275.00			

BRISA - 3-PACK					
MODEL		WHITE	SANDSTONE	BROWN	BLACK
Brisa 7771** Single Door	Short	\$767.00			
	Standard	\$767.00			
	Tall	\$895.00			
Brisa 7773*** Sliding Door	Standard	\$767.00			

SPECIFY WHEN ORDERING:

- A. Quantity
- B. Product Model Number
- C. Short, Standard, Tall
- D. Frame Color

- Mounts easily on a minimum 1" x 1" surface area.
- No cut, quick-snap track installs easily and adjusts to widths between 32" and 36" for single and sliding door applications, and between 68" and 72" for double doors.

Note: If door is less than 32" wide (single) or 68" wide (double), two simple cuts are required.

*Based on average DIY skills and standard door application, widths 32"-36" (single), 68"-72" (double).

**The Brisa retractable door screen is a face (surface) mounted product.

***The Brisa retractable door screen for sliding patio doors has been specifically designed and sized to mount on a typical 6'8" tall sliding patio door.

Note: See your Larson seller or visit larsondoors.com for details on limited warranties and exclusions. Not intended to keep children or pets inside. Product finish colors are approximate; actual finish colors may vary.

Feature Overview

The Brisa retractable screen offers innovative features and smooth operation without compromising on style.

ASSEMBLY

- Simple-to-install quick-snap track means fewer assembly steps and an easier installation experience.
- Speed reducer provides safety and controlled retraction.
- Fits both left- and right-hand inswing and outswing doors with no modification.

SCREEN FABRIC

- Anti-fraying double weave at the top and bottom of the screen fabric.
- Durable screen fabric with subtle safety stripes woven into the fabric provide faint visual cues to help prevent walk-through. Top stripes are for people and bottom for pets.

HANDLE

- Ergonomically designed handle with latch/lock offers simple and secure one-hand operation.
- Locking handle.
- Handle latch type: mechanical latch.

STYLES

- Wide range of standard sizes, including 96" high doors.
- Telescoping width adjustment allows the screen to fit a range of opening widths.
- Stock sizes that fit most typical door sizes.
- Available in: single door, double door and sliding patio door sizes.



30-minute or less installation.*

HANDING

Adjusts easily to fit a left- or right-hand application.

SMOOTH GLIDING, NO SLAMMING

Screen retracts all the way without assistance or banging.

SILL PLATE

Aluminum sill plate with adjustable extenders (no gaps, blunt or sharp edges to step on).

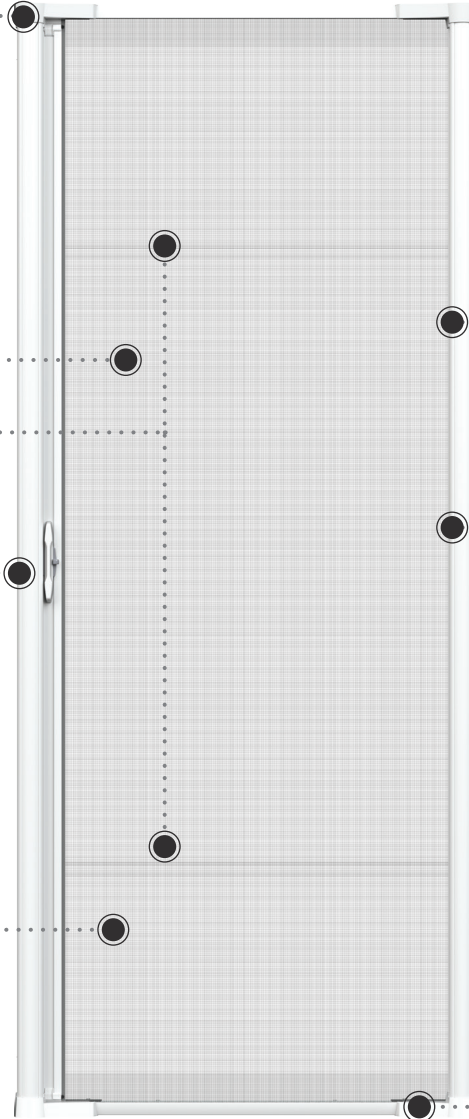

Additional Sizing & Application Detail

Shown below are the size ranges for Brisa single, double and slider options.

The Brisa screen for single- and double-panel hinged doors is surface/face mounted to the front surface of the door brickmould/trim (**see image**).

Doors, door frames and door sills vary by manufacturer. An advantage of surface mounting the Brisa screen is the ability to position it up or down in the opening to best fit the door frame before fastening in place. This makes the Brisa screen extremely versatile and able to fit multiple opening heights.

6'8" high door heights are the most common, however heights vary by geographic region. When installing on a single- or double-hinged door, a $\frac{3}{4}$ " or greater mounting surface depth is required inside the door frame. For 6'8" high sliding patio doors, refer to installation and mounting instructions.

The Brisa retractable screen door is a surface/face mounted product. However, sizing is determined by door opening rather than the intended placement of the Brisa on the exterior door trim or brickmould. Measure for your Brisa by true opening size.

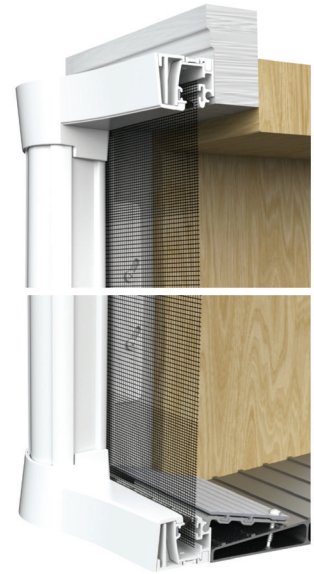

Surface/Face Mounting on a Traditional Hinged Door.

DOOR TYPE	MODEL HEIGHT	FITS OPENING WIDTHS	FITS OPENING HEIGHTS	TIP-TO-TIP HEIGHT DIMENSIONS OF ASSEMBLED SCREEN HOUSING
Single	Short	32"-36"	78"-79" (e.g. 6'6" doors)	79"
Single	Standard	32"-36"	80"-81" (e.g. 6'8" doors)	81-3/8"
Single	Tall	32"-36"	96"-97" (e.g. 8'0" doors)	97-3/8"
Double	Short	68"-72"	78"-79" (e.g. 6'6" doors)	79"
Double	Standard	68"-72"	80"-81" (e.g. 6'8" doors)	81-3/8"
Double	Tall	68"-72"	96"-97" (e.g. 8'0" doors)	97-3/8"
Slider	Standard	32"-36"	78"-79" (e.g. 6'6" doors)	79-1/4"

- Two cuts required if less than 32" for single doors and 68" for double doors.
- Door designs and thresholds vary. It may be possible to position the screen upwards or downwards to fit an opening size not listed. In such cases, a filler board or trim may be needed. Doors with transoms above the door may also require a filler board or trim before or after installing the screen. Always ensure the bottom of the screen is firmly supported (**see page 58**).
- The Brisa slider fits most traditional 6'8" tall patio doors and includes different mounting hardware and a slightly shorter screen housing. This allows the system to rest in the opening as needed (**see page 62**).

Screen Height Position on a Hinged Door

TYPICAL INSTALLATION:

No filler board should be necessary. The unit can be moved up and down to fit the opening as desired.

OTHER INSTALLATION:

A filler board (trim) may be needed if the screen is positioned differently or if the opening height is outside of the recommended size range.

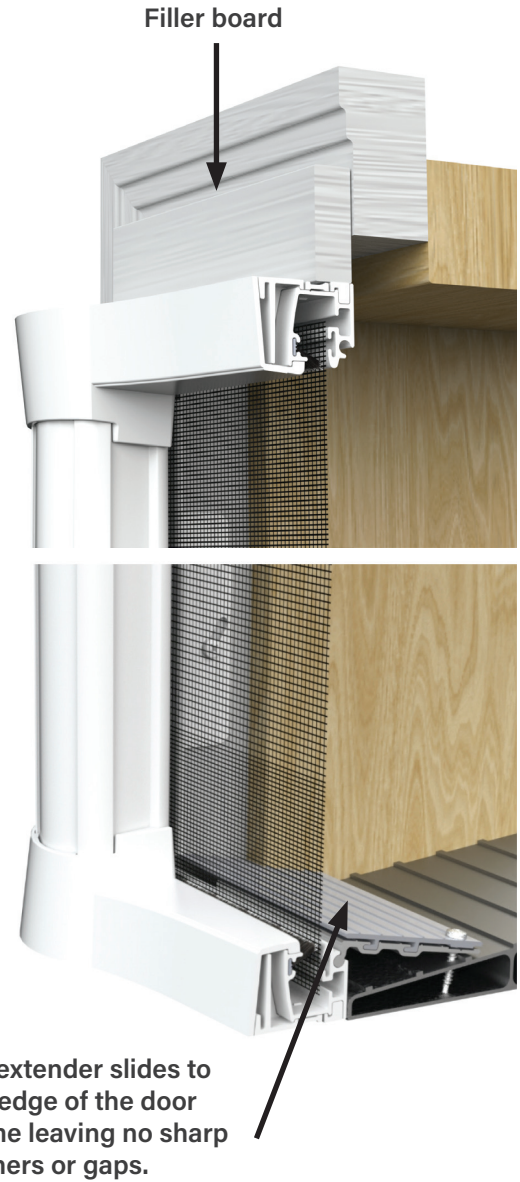

Screens for Single Panel Hinged Doors

Available in three heights – short, standard and tall – to fit most common doors.

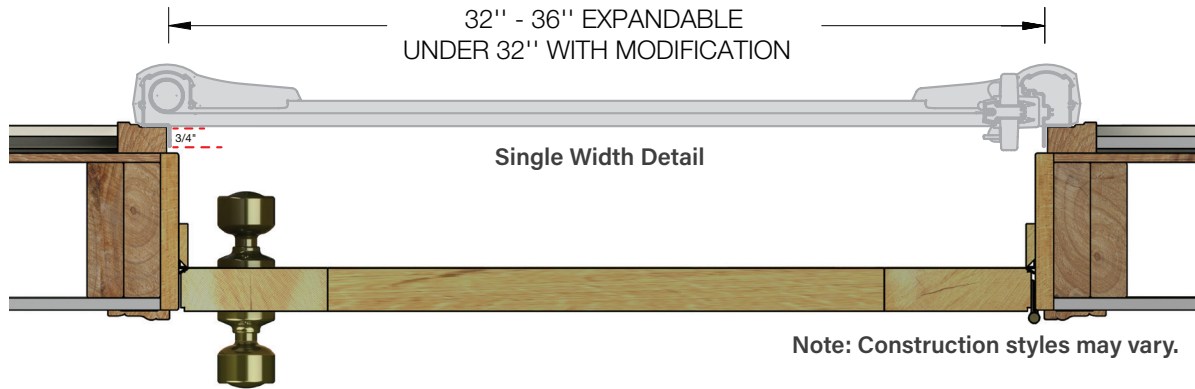

Component Dimensions – Single Screen

A mounting flange is positioned 1-1/16" from the outer edge at the back of the screen housing and decorative housing.

The mounting flange requires this 3/4" depth for mounting to the side brickmould/door trim.

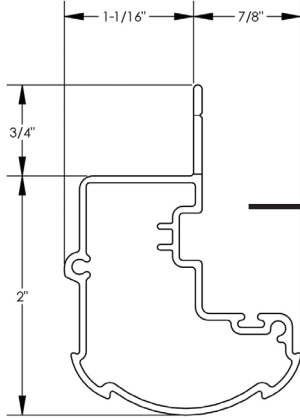

Decorative Housing Profile

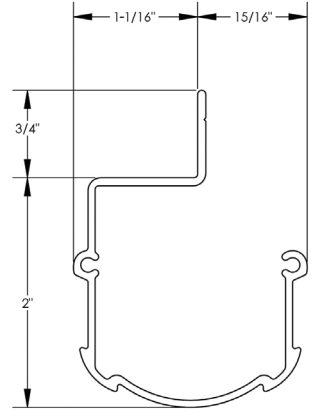

Screen Housing Profile

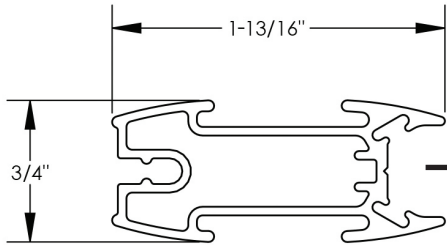

Slider Bar Profile

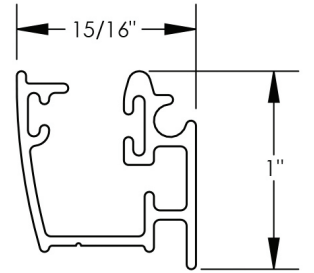

Top Track/ Bottom Track

Shown in Locked Position

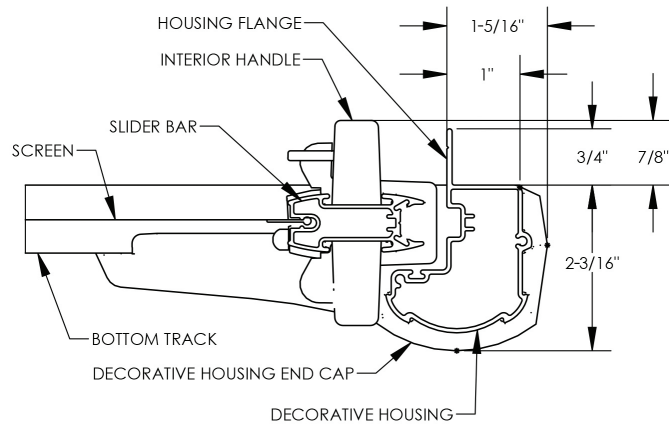

Screens for Double Panel Hinged Doors

Available in three heights – short, standard and tall – to fit most common doors.

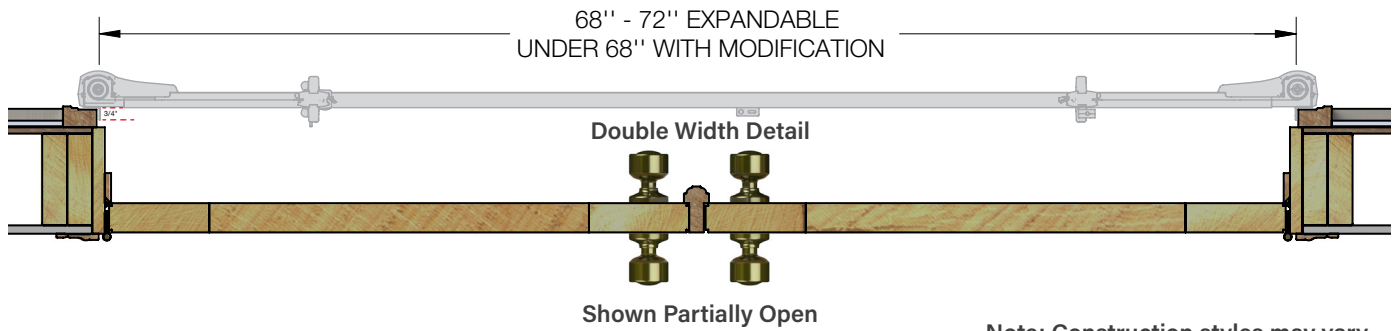

Brisa for Sliding Patio Doors

The Brisa screen for single sliding patio doors is for use with traditional 6'8" high sliding patio doors. **(Fig. A)** This screen features unique mounting hardware and is specially sized so that the screen housing will rest and secure to the outer door frame. The doorframe must have a surface to attach the mounting bracket screws. The distance between these screws is 78-1/2".

(See Fig. C & D) Please see the following images and visit larsondoors.com/screens/brisa-retractable-screens to view the installation video and instructions.

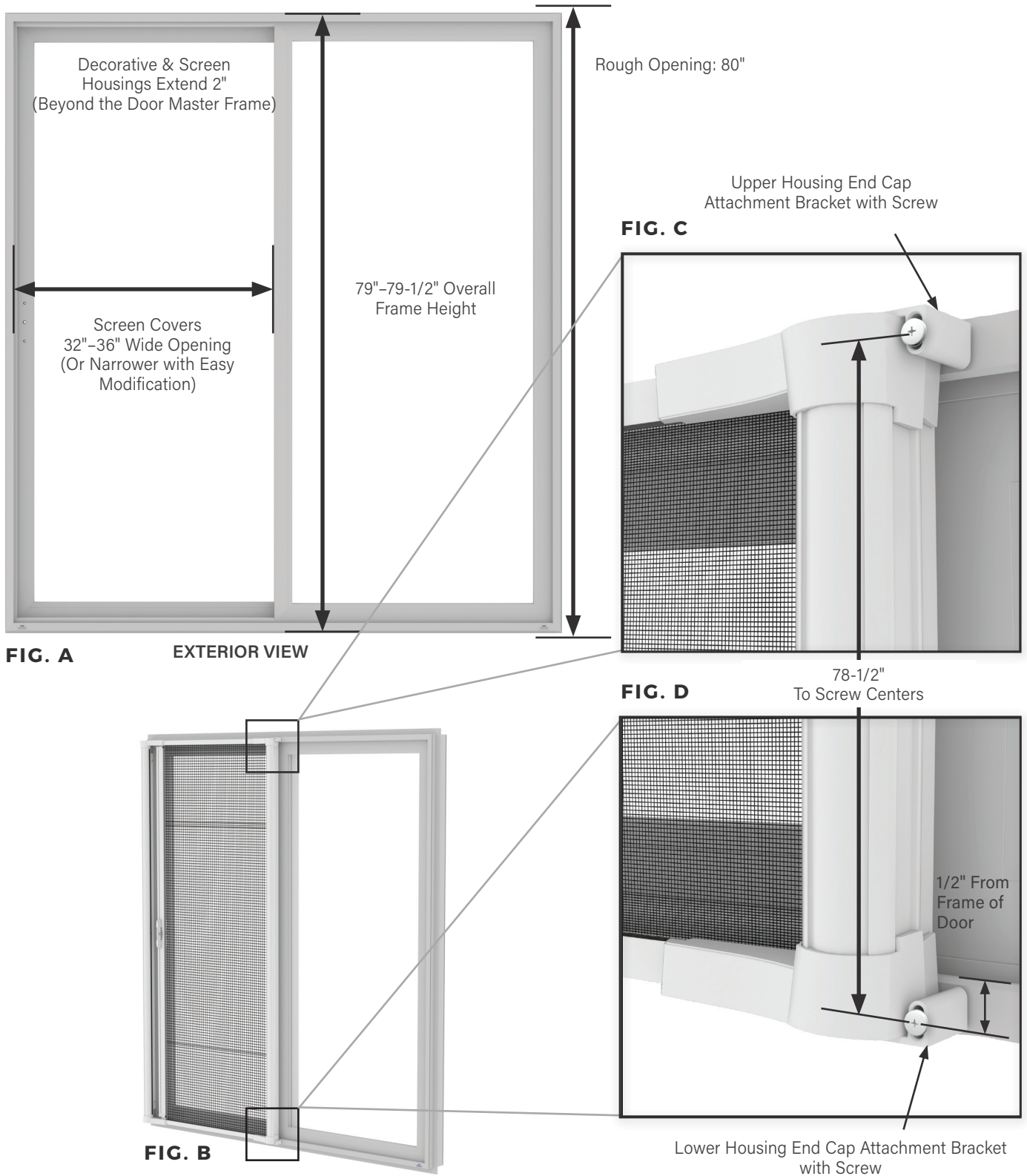



Model Shown: 7723 Slider
White Frame

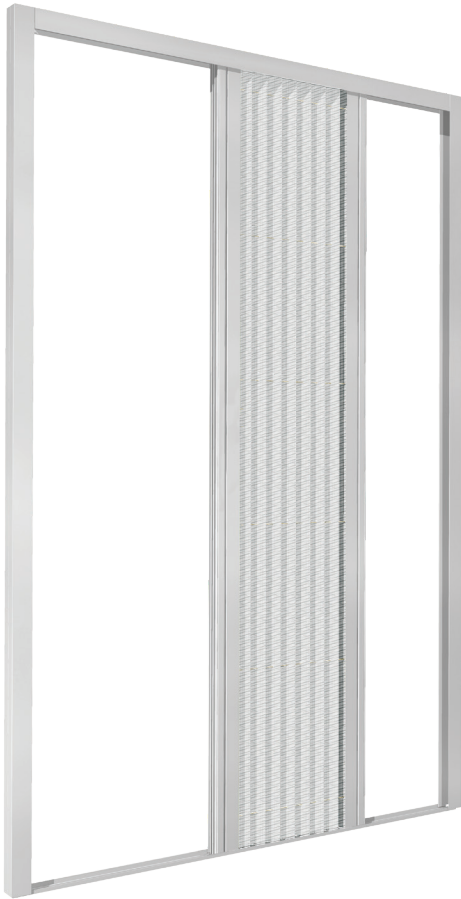

Model Shown: WS1000
Single Wall Screen

Retractable Wall Screen

WS1000 (Single), WS2000 (Double)

A NEW HORIZON FOR VENTILATION

The ideal screen solution for bi-folding, lift-n-slide and other large opening doors and windows, the Retractable Wall Screen fills the home with fresh air.

TOP BENEFITS

- **Fresh style.** Elegant, pleated fabric provides ventilation with refined design.
- **Smooth operation.** Easily move and stop the screen at any position with one hand.
- **Custom-made ventilation.** Designed to fit openings up to 315" wide and 118" high.

ADDITIONAL FEATURES

- The single screen WS1000 can open from either end.
- The double screen WS2000 features two panels that meet in the middle.
- Pre-assembled for easy recessed installation.

5 YEAR
LIMITED WARRANTY

5-YEAR
WARRANTY

CONFIGURATIONS

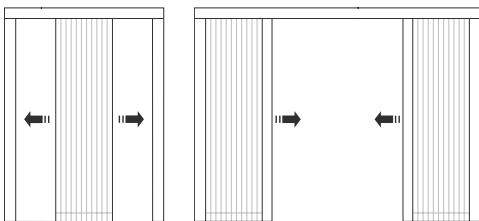

Single - WS1000

Double - WS2000

FRAME COLORS



White

Desert Tan

Brownstone

Black

PRODUCT DETAILS

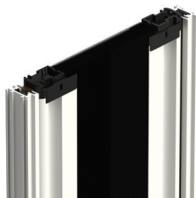

Screen Panel
Assembly
WS1000 (qty. 1)



Screen Panel Assembly
WS2000 (qty. 2)



Top
Guide



Side
Profile



Bottom
Guide

PROFILES

MODEL - WS1000 (SINGLE)

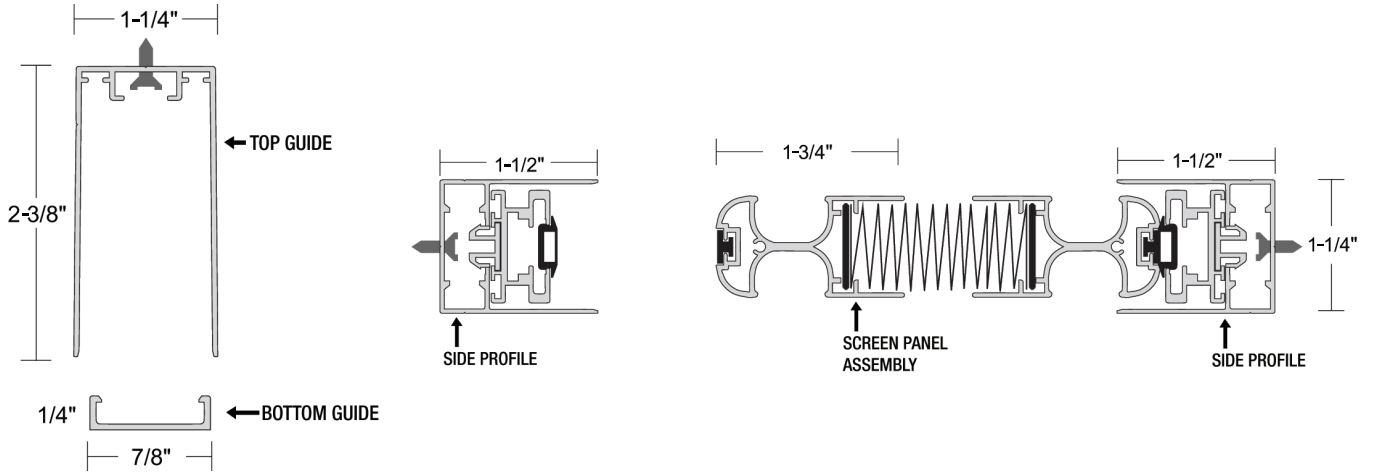

MODEL - WS2000 (DOUBLE)

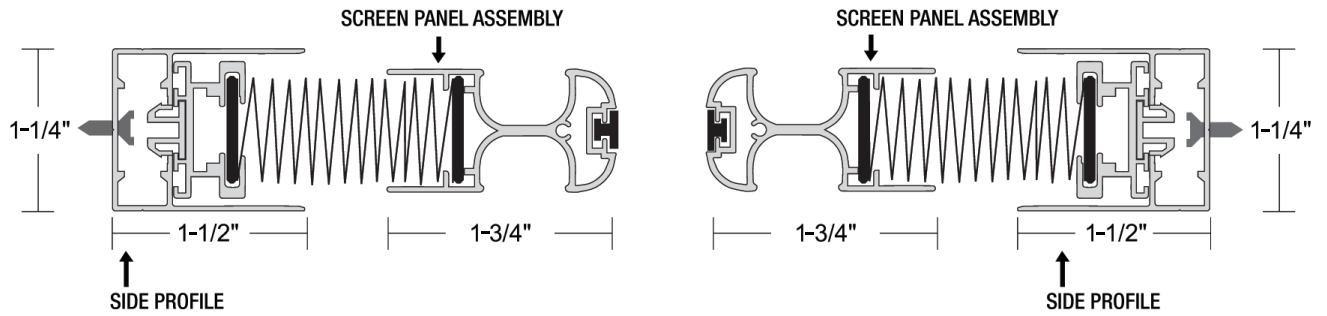

Model Shown: WS100
Desert Tan Frame

LIST PRICE

WS1000 - SINGLE PANEL										
HEIGHT	114-1/8" - 118"	\$1,425.00	\$1,617.00	\$1,771.00	\$1,865.00	\$1,964.00				
	108-1/8" - 114"	\$1,392.00	\$1,568.00	\$1,727.00	\$1,815.00	\$1,947.00				
	102-1/8" - 108"	\$1,309.00	\$1,462.00	\$1,614.00	\$1,712.00	\$1,788.00	\$1,848.00			
	96-1/8" - 102"	\$1,172.00	\$1,326.00	\$1,480.00	\$1,573.00	\$1,694.00	\$1,744.00	\$1,826.00		
	72-1/8" - 96"	\$743.00	\$941.00	\$1,238.00	\$1,337.00	\$1,408.00	\$1,496.00	\$1,562.00	\$1,639.00	
	24" - 72"	\$671.00	\$831.00	\$1,139.00	\$1,232.00	\$1,315.00	\$1,381.00	\$1,430.00	\$1,480.00	
UPTO	24" - 48"	48-1/8" - 72"	72-1/8" - 96"	96-1/8" - 120"	120-1/8" - 138"	138-1/8" - 154"	154-1/8" - 166"	166-1/8" - 177"		
WIDTH										

24" Minimum Width & Height | Maximum Size 114.6 sq. ft. (W x H/144)

WS2000 - DOUBLE PANEL												
HEIGHT	114-1/8" - 118"	\$2,486.00	\$2,706.00	\$2,959.00	\$3,245.00	\$3,487.00	\$3,685.00	\$3,905.00				
	108-1/8" - 114"	\$2,409.00	\$2,629.00	\$2,882.00	\$3,157.00	\$3,399.00	\$3,586.00	\$3,795.00	\$3,938.00			
	102-1/8" - 108"	\$2,244.00	\$2,453.00	\$2,684.00	\$2,926.00	\$3,157.00	\$3,333.00	\$3,520.00	\$3,663.00	\$3,729.00		
	96-1/8" - 102"	\$2,024.00	\$2,233.00	\$2,464.00	\$2,794.00	\$3,003.00	\$3,168.00	\$3,355.00	\$3,476.00	\$3,542.00	\$3,608.00	
	72-1/8" - 96"	\$1,826.00	\$1,980.00	\$2,211.00	\$2,497.00	\$2,728.00	\$2,893.00	\$3,069.00	\$3,201.00	\$3,267.00	\$3,322.00	
	24" - 72"	\$1,661.00	\$1,826.00	\$2,046.00	\$2,288.00	\$2,464.00	\$2,618.00	\$2,772.00	\$2,882.00	\$2,948.00	\$3,003.00	
UPTO	40" - 72"	72-1/8" - 96"	96-1/8" - 132"	132-1/8" - 168"	168-1/8" - 204"	204-1/8" - 240"	240-1/8" - 276"	276-1/8" - 300"	300-1/8" - 312"	312-1/8" - 315"		
WIDTH												

40" Minimum Width; 24" Minimum Height | Maximum size 229-1/5 sq. ft. (W x H/144)

SPECIFY WHEN ORDERING:

- Quantity
- Product Model (WS1000 for Single Panel or WS2000 for Double Panel)
- Frame Color
- Net Screen Opening Size (W x H)

- Measuring & Installation: Designed to be installed within a framed opening (e.g. inset/recess mounted). 1-1/4" or deeper mounting surface required. Prior to measuring, be sure the opening is plumb, level and square and that the bottom guide has a flat, stable and smooth surface to rest on. Adjust the opening as needed.
- 2-piece top guide when over 180" wide.

Note: Extended lead times may apply.

Note: Larson retractable screens provide insect protection and support fresh, natural ventilation in low-wind conditions. Unlike 4-sided rigid framed screens, Larson retractable screens move in and out of a protective cassette and the exposed surface area and edges of the fabric are flexible. Consequently, the wind speed that a retractable screen can withstand (e.g. before the edges of the screen fabric may push out of the guide rails), will depend on the width and height of the opening, the openness factor of the specific screen fabric and other design factors of the model. Retractable screens are not to be kept open or continually exposed to wind, sun, rain or other harsh conditions. Please be sure to use your retractable screen only during low-wind conditions.

Measuring Guide:

WALL SCREEN AND INSPIRE (MULTI-PANEL) SCREENS

Measure for the net screen opening dimensions.

Begin by deciding where best to position the screen. The opening must be plumb, level and square and, the bottom guide of the retractable screen must rest on a flat, level and solid surface. Make any needed adjustments to the opening (or plan and allow for shimming) before measuring for the screen.

Determine the **net screen opening dimension** (width x height) as measured from the outermost edges of where the retractable screen will rest. Screens are then made to fit these dimensions. Manufacturing tolerances are **plus or minus 1/16"**. Because of this, we recommend that you **deduct an additional 1/16"** from the width and height dimensions that you submit in order to assure that the screen is not too tight in the opening during installation.

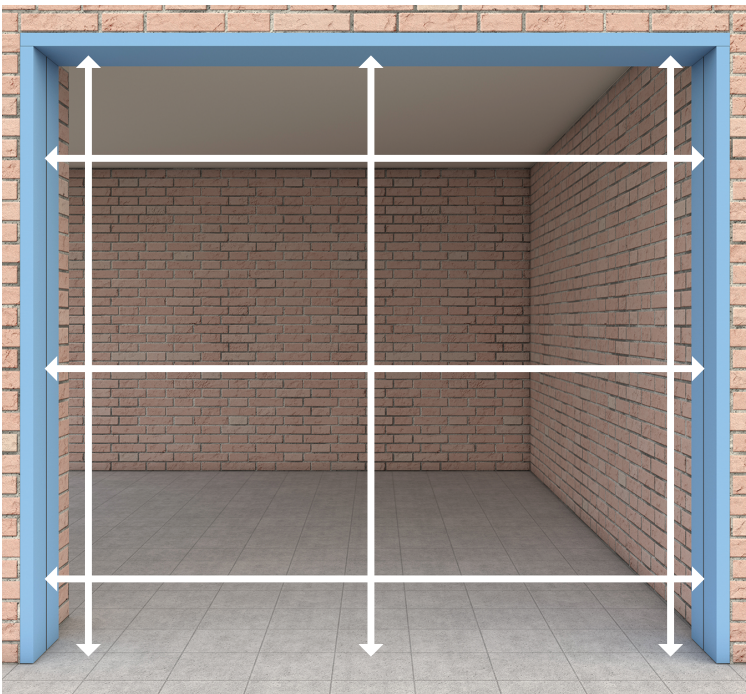

RECOMMENDED INSTALLATION TYPE

Inside The Frame Installation

(Recess/Inset Mounted)

RECORD FINAL NET SCREEN OPENING DIMENSIONS

W _____

H _____

(Deduct 1/16" from the width and height to order).

BEFORE YOU MEASURE

Before measuring, ordering and installing the screen, ensure that the opening is plumb, level and square and that the bottom of the opening has a flat, stable and smooth mounting surface. If needed, add a metal strip or other material (sourced elsewhere), to create a suitable surface for mounting the bottom guide rail of the retractable screen.

EXAMPLES

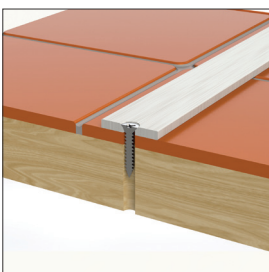

Uneven Tile Floor



Aggregate Cement Floor

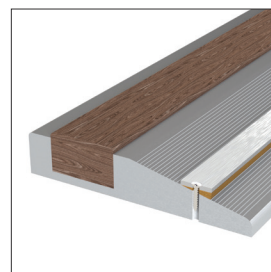

Angled Door Sill

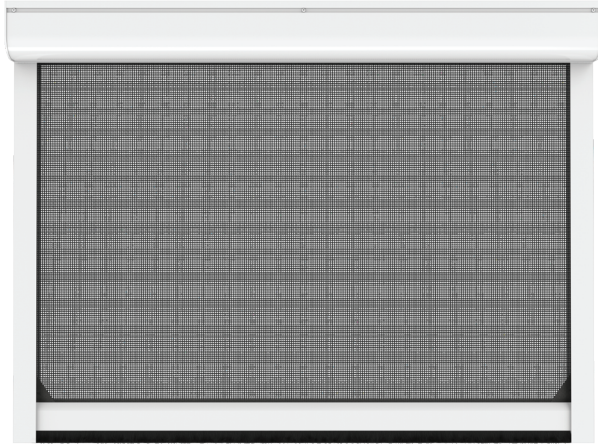

Retractable Motorized Screen

Models 6+, 7+, 8+, 9+, 10+

ENJOY THE VIEW IN COMFORT

Protect against insects, debris, sun, heat and wind with the Larson Retractable Motorized Screen and its selection of five purpose-built screens that fully retract for an unobstructed view.

TOP BENEFITS

- **Effortless operation.** Conveniently raise and lower the screen with the push of a button on the remote – or let the automatic sun-wind sensor adjust the screen to match the weather.
- **Engineered endurance.** The edge of the screen fabric is sonic welded to heavy-duty zipper tracks, sealing gaps on all sides and providing extra durability.
- **Custom-made solutions.** Designed to fit openings up to 20' wide and 12' high, depending on screen type.

ALUMINUM FRAME COLORS



TUFFSCREEN. SCREEN COLORS

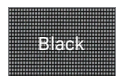

TUFFSCREEN. NO-SEE-UMS SCREEN COLORS

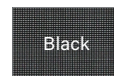

SUNTEX. 80 SCREEN COLORS

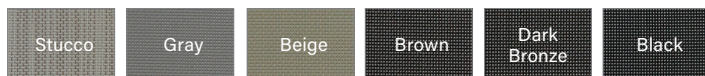

SUNTEX. 95 SCREEN COLORS

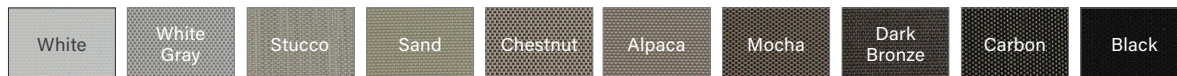

CLEAR VINYL WITH WEBLON® SURROUND COLORS

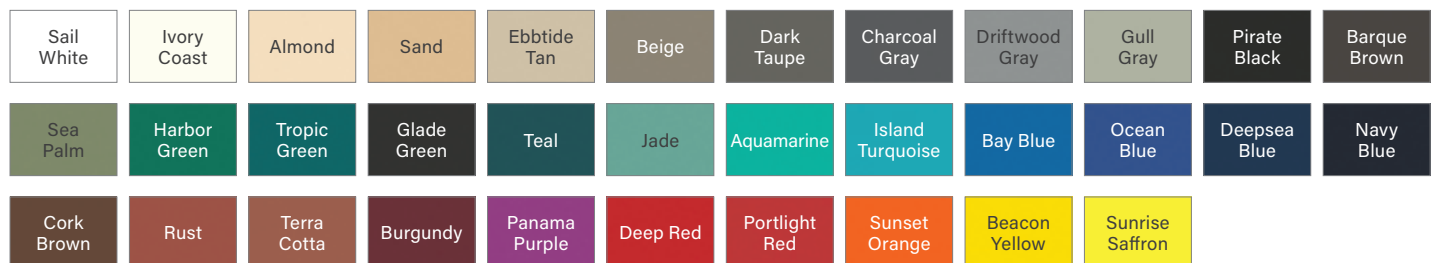



Model Shown: 9+
SunTex 80 Screen in Beige



Model Shown: 6+
TuffScreen No-See-Ums in Black

Note: See your Larson seller or visit larsondoors.com for details on available product sizes and options. Product finish colors are approximate; actual finish colors may vary. This is a motorized screen, which requires a separate power source to operate. The screen will not move up or down without power. We recommend that you purchase a backup power supply. Windy conditions may affect the performance of the screen. Retract the screen in windy circumstances, during inclement weather and when not needed to support immediate ventilation or prolonged periods of time when not used. Not intended to keep pets or children inside. This product contains one or more devices that comply with UL standards for electrical safety and with part 15 of FCC Rules for radio frequency devices.

Insect Screens

Experience outdoor living without the bugs. Insect screens safeguard against airborne pests and are made of durable, vinyl-coated polyester that resists tears and punctures.

TUFFSCREEN.

Protects against airborne pests.

TUFFSCREEN. NO-SEE-UMS

Protects against even the smallest airborne pests with a tighter weave.

LIST PRICE

6+ INSECT SCREEN 4.5" CASSETTE				Remote Sold Separately						
	1' – 3' H	4' H	5' H	6' H	7' H	8' H	9' H	10' H	11' H	12' H
3' W	\$1,923.00	\$1,923.00	\$2,058.00	\$2,171.00	\$2,409.00	\$2,444.00	\$2,537.00			
4' W	\$1,998.00	\$1,998.00	\$2,136.00	\$2,249.00	\$2,490.00	\$2,527.00	\$2,615.00			
5' W	\$2,071.00	\$2,071.00	\$2,211.00	\$2,327.00	\$2,565.00	\$2,602.00	\$2,695.00			
6' W	\$2,154.00	\$2,154.00	\$2,291.00	\$2,402.00	\$2,642.00	\$2,685.00	\$2,778.00			
7' W	\$2,231.00	\$2,231.00	\$2,369.00	\$2,487.00	\$2,725.00	\$2,763.00	\$2,856.00			
8' W	\$2,311.00	\$2,311.00	\$2,452.00	\$2,565.00	\$2,805.00	\$2,843.00	\$2,933.00			
9' W	\$2,392.00	\$2,392.00	\$2,530.00	\$2,640.00	\$2,878.00	\$2,926.00	\$3,014.00			
10' W	\$2,469.00	\$2,469.00	\$2,607.00	\$2,723.00	\$2,961.00	\$3,004.00	\$3,096.00			
11' W	\$2,545.00	\$2,545.00	\$2,688.00	\$2,798.00	\$3,039.00	\$3,079.00	\$3,174.00			
12' W	\$2,625.00	\$2,625.00	\$2,763.00	\$2,878.00	\$3,116.00	\$3,164.00	\$3,257.00			
13' W	\$2,705.00	\$2,705.00	\$2,843.00	\$2,958.00	\$3,197.00	\$3,242.00	\$3,332.00			
14' W	\$2,785.00	\$2,785.00	\$2,926.00	\$3,036.00	\$3,274.00	\$3,322.00	\$3,412.00			
15' W	\$2,863.00	\$2,863.00	\$3,001.00	\$3,114.00	\$3,355.00	\$3,402.00	\$3,495.00			
16' W	\$2,903.00	\$2,903.00	\$3,041.00	\$3,157.00	\$3,397.00	\$3,427.00	\$3,520.00			
16.5' W	\$2,943.00	\$2,943.00	\$3,081.00	\$3,197.00	\$3,437.00	\$3,467.00	\$3,560.00			

Round up to next foot for accurate pricing (e.g. a 10'1" w x 8'2" h opening would be 11' w x 9' h).

7+ INSECT SCREEN 5.5" CASSETTE				Remote Sold Separately						
3' W	\$2,913.00	\$2,913.00	\$2,913.00	\$2,913.00	\$2,913.00	\$2,948.00	\$2,986.00	\$3,021.00	\$3,056.00	\$3,091.00
4' W	\$2,996.00	\$2,996.00	\$2,996.00	\$2,996.00	\$2,996.00	\$3,034.00	\$3,157.00	\$3,194.00	\$3,229.00	\$3,264.00
5' W	\$3,079.00	\$3,079.00	\$3,079.00	\$3,079.00	\$3,079.00	\$3,119.00	\$3,242.00	\$3,277.00	\$3,314.00	\$3,352.00
6' W	\$3,162.00	\$3,162.00	\$3,162.00	\$3,162.00	\$3,162.00	\$3,202.00	\$3,327.00	\$3,284.00	\$3,319.00	\$3,357.00
7' W	\$3,244.00	\$3,244.00	\$3,244.00	\$3,244.00	\$3,244.00	\$3,287.00	\$3,412.00	\$3,370.00	\$3,407.00	\$3,445.00
8' W	\$3,327.00	\$3,327.00	\$3,327.00	\$3,327.00	\$3,327.00	\$3,370.00	\$3,500.00	\$3,508.00	\$3,535.00	\$3,540.00
9' W	\$3,407.00	\$3,407.00	\$3,407.00	\$3,407.00	\$3,407.00	\$3,455.00	\$3,583.00	\$3,600.00	\$3,615.00	\$3,630.00
10' W	\$3,495.00	\$3,495.00	\$3,495.00	\$3,495.00	\$3,495.00	\$3,538.00	\$3,673.00	\$3,628.00	\$3,676.00	\$3,718.00
11' W	\$3,578.00	\$3,578.00	\$3,578.00	\$3,578.00	\$3,578.00	\$3,620.00	\$3,756.00	\$3,793.00	\$3,801.00	\$3,808.00
12' W	\$3,655.00	\$3,655.00	\$3,655.00	\$3,655.00	\$3,655.00	\$3,706.00	\$3,844.00	\$3,856.00	\$3,889.00	\$3,899.00
13' W	\$3,741.00	\$3,741.00	\$3,741.00	\$3,741.00	\$3,741.00	\$3,791.00	\$3,924.00	\$3,939.00	\$3,961.00	\$3,986.00
14' W	\$3,826.00	\$3,826.00	\$3,826.00	\$3,826.00	\$3,826.00	\$3,876.00	\$3,956.00	\$3,981.00	\$4,027.00	\$4,092.00
15' W	\$3,909.00	\$3,909.00	\$3,909.00	\$3,909.00	\$3,909.00	\$3,956.00	\$4,009.00	\$4,064.00	\$4,117.00	\$4,170.00
16' W	\$3,951.00	\$3,951.00	\$3,951.00	\$3,951.00	\$3,951.00	\$3,984.00	\$4,022.00	\$4,092.00	\$4,147.00	\$4,182.00
17' W	\$3,961.00	\$3,961.00	\$3,961.00	\$3,961.00	\$3,961.00	\$3,997.00	\$4,054.00	\$4,122.00	\$4,187.00	\$4,227.00
18' W	\$3,994.00	\$3,994.00	\$3,994.00	\$3,994.00	\$3,994.00	\$4,054.00	\$4,104.00	\$4,162.00	\$4,217.00	\$4,275.00
19' W	\$4,074.00	\$4,074.00	\$4,074.00	\$4,074.00	\$4,074.00	\$4,134.00	\$4,190.00	\$4,247.00	\$4,307.00	\$4,365.00
20' W	\$4,483.00	\$4,483.00	\$4,483.00	\$4,483.00	\$4,483.00	\$4,543.00	\$4,598.00	\$4,651.00	\$4,719.00	\$4,776.00

Round up to next foot for accurate pricing (e.g. a 10'1" w x 8'2" h opening would be 11' w x 9' h).

Solar and Privacy Screens

Create a private getaway free from the heat of the sun and the gaze of your neighbors. Solar and privacy screens block the sun and its heat for cooler outdoor spaces with added privacy.

SUNTEX. 80

Provides approximately 75% UV blockage for shade and privacy.

SUNTEX. 95

Provides approximately 95% UV blockage for excellent shade and privacy.

LIST PRICE

8+ SOLAR AND PRIVACY SCREEN 4.5" CASSETTE Remote Sold Separately										
	1' – 3' H	4' H	5' H	6' H	7' H	8' H	9' H	10' H	11' H	12' H
3' W	\$2,078.00	\$2,078.00	\$2,213.00	\$2,326.00	\$2,564.00	\$2,600.00	\$2,692.00			
4' W	\$2,153.00	\$2,153.00	\$2,291.00	\$2,404.00	\$2,645.00	\$2,682.00	\$2,770.00			
5' W	\$2,226.00	\$2,226.00	\$2,366.00	\$2,482.00	\$2,720.00	\$2,758.00	\$2,850.00			
6' W	\$2,309.00	\$2,309.00	\$2,447.00	\$2,557.00	\$2,798.00	\$2,840.00	\$2,933.00			
7' W	\$2,386.00	\$2,386.00	\$2,524.00	\$2,642.00	\$2,880.00	\$2,918.00	\$3,011.00			
8' W	\$2,467.00	\$2,467.00	\$2,607.00	\$2,720.00	\$2,961.00	\$2,998.00	\$3,089.00			
9' W	\$2,547.00	\$2,547.00	\$2,685.00	\$2,795.00	\$3,033.00	\$3,081.00	\$3,169.00			
10' W	\$2,625.00	\$2,625.00	\$2,763.00	\$2,878.00	\$3,116.00	\$3,159.00	\$3,252.00			
11' W	\$2,700.00	\$2,700.00	\$2,843.00	\$2,953.00	\$3,194.00	\$3,234.00	\$3,329.00			
12' W	\$2,780.00	\$2,780.00	\$2,918.00	\$3,033.00	\$3,272.00	\$3,319.00	\$3,412.00			
13' W	\$2,860.00	\$2,860.00	\$2,998.00	\$3,114.00	\$3,352.00	\$3,397.00	\$3,487.00			
14' W	\$2,941.00	\$2,941.00	\$3,081.00	\$3,191.00	\$3,430.00	\$3,477.00	\$3,567.00			
15' W	\$3,018.00	\$3,018.00	\$3,156.00	\$3,269.00	\$3,510.00	\$3,557.00	\$3,650.00			
16' W	\$3,058.00	\$3,058.00	\$3,196.00	\$3,312.00	\$3,552.00	\$3,583.00	\$3,675.00			
16.5' W	\$3,099.00	\$3,099.00	\$3,237.00	\$3,352.00	\$3,593.00	\$3,623.00	\$3,715.00			

Round up to next foot for accurate pricing (e.g. a 10'1" w x 8'2" h opening would be 11' w x 9' h).

9+ SOLAR AND PRIVACY SCREEN 5.5" CASSETTE Remote Sold Separately										
	1' – 3' H	4' H	5' H	6' H	7' H	8' H	9' H	10' H	11' H	12' H
3' W	\$2,921.00	\$2,921.00	\$2,921.00	\$2,921.00	\$3,069.00	\$3,104.00	\$3,141.00	\$3,176.00	\$3,211.00	\$3,247.00
4' W	\$3,004.00	\$3,004.00	\$3,004.00	\$3,004.00	\$3,151.00	\$3,189.00	\$3,312.00	\$3,349.00	\$3,384.00	\$3,420.00
5' W	\$3,086.00	\$3,086.00	\$3,086.00	\$3,086.00	\$3,234.00	\$3,274.00	\$3,397.00	\$3,432.00	\$3,470.00	\$3,507.00
6' W	\$3,169.00	\$3,169.00	\$3,169.00	\$3,169.00	\$3,317.00	\$3,357.00	\$3,482.00	\$3,440.00	\$3,475.00	\$3,512.00
7' W	\$3,252.00	\$3,252.00	\$3,252.00	\$3,252.00	\$3,399.00	\$3,442.00	\$3,567.00	\$3,525.00	\$3,562.00	\$3,600.00
8' W	\$3,335.00	\$3,335.00	\$3,335.00	\$3,335.00	\$3,482.00	\$3,525.00	\$3,655.00	\$3,663.00	\$3,690.00	\$3,695.00
9' W	\$3,415.00	\$3,415.00	\$3,415.00	\$3,415.00	\$3,562.00	\$3,610.00	\$3,738.00	\$3,756.00	\$3,771.00	\$3,786.00
10' W	\$3,503.00	\$3,503.00	\$3,503.00	\$3,503.00	\$3,650.00	\$3,693.00	\$3,828.00	\$3,783.00	\$3,831.00	\$3,873.00
11' W	\$3,585.00	\$3,585.00	\$3,585.00	\$3,585.00	\$3,733.00	\$3,776.00	\$3,911.00	\$3,949.00	\$3,956.00	\$3,964.00
12' W	\$3,663.00	\$3,663.00	\$3,663.00	\$3,663.00	\$3,811.00	\$3,861.00	\$3,999.00	\$4,011.00	\$4,044.00	\$4,054.00
13' W	\$3,748.00	\$3,748.00	\$3,748.00	\$3,748.00	\$3,896.00	\$3,946.00	\$4,079.00	\$4,094.00	\$4,117.00	\$4,142.00
14' W	\$3,834.00	\$3,834.00	\$3,834.00	\$3,834.00	\$3,981.00	\$4,031.00	\$4,112.00	\$4,137.00	\$4,182.00	\$4,247.00
15' W	\$3,916.00	\$3,916.00	\$3,916.00	\$3,916.00	\$4,064.00	\$4,112.00	\$4,164.00	\$4,219.00	\$4,272.00	\$4,325.00
16' W	\$3,959.00	\$3,959.00	\$3,959.00	\$3,959.00	\$4,107.00	\$4,139.00	\$4,177.00	\$4,247.00	\$4,302.00	\$4,337.00
17' W	\$3,969.00	\$3,969.00	\$3,969.00	\$3,969.00	\$4,117.00	\$4,152.00	\$4,209.00	\$4,277.00	\$4,342.00	\$4,382.00
18' W	\$4,002.00	\$4,002.00	\$4,002.00	\$4,002.00	\$4,149.00	\$4,209.00	\$4,260.00	\$4,317.00	\$4,372.00	\$4,430.00
19' W	\$4,082.00	\$4,082.00	\$4,082.00	\$4,082.00	\$4,229.00	\$4,290.00	\$4,345.00	\$4,402.00	\$4,463.00	\$4,520.00
20' W	\$4,491.00	\$4,491.00	\$4,491.00	\$4,491.00	\$4,638.00	\$4,698.00	\$4,754.00	\$4,806.00	\$4,874.00	\$4,932.00

Round up to next foot for accurate pricing (e.g. a 10'1" w x 8'2" h opening would be 11' w x 9' h).

Vinyl Screens

Transform outdoor spaces into multi-season rooms with the outstanding climate control of vinyl screens. A transparent plastic panel provides a view while the screen is down. Features your choice of colored fabric borders. **Heavy-duty bottom bar is included.**

CLEAR VINYL WITH WEBLON® SURROUND

Provides climate control to the enclosed space while a transparent plastic panel maintains the view.

LIST PRICE

10+ VINYL SCREEN 5.5" CASSETTE Remote Sold Separately									
	1' – 3' H	4' H	5' H	6' H	7' H	8' H	9' H	10' H	11' H
3' W	\$4,095.00	\$4,095.00	\$4,095.00	\$4,095.00	\$4,095.00	\$4,131.00	\$4,168.00	\$4,203.00	\$4,238.00
4' W	\$4,178.00	\$4,178.00	\$4,178.00	\$4,178.00	\$4,178.00	\$4,216.00	\$4,339.00	\$4,376.00	\$4,411.00
5' W	\$4,261.00	\$4,261.00	\$4,261.00	\$4,261.00	\$4,261.00	\$4,301.00	\$4,424.00	\$4,459.00	\$4,497.00
6' W	\$4,344.00	\$4,344.00	\$4,344.00	\$4,344.00	\$4,344.00	\$4,384.00	\$4,509.00	\$4,467.00	\$4,502.00
7' W	\$4,426.00	\$4,426.00	\$4,426.00	\$4,426.00	\$4,426.00	\$4,469.00	\$4,594.00	\$4,552.00	\$4,589.00
8' W	\$4,509.00	\$4,509.00	\$4,509.00	\$4,509.00	\$4,509.00	\$4,552.00	\$4,682.00	\$4,690.00	\$4,717.00
9' W	\$4,589.00	\$4,589.00	\$4,589.00	\$4,589.00	\$4,589.00	\$4,637.00	\$4,765.00	\$4,782.00	\$4,798.00
10' W	\$4,677.00	\$4,677.00	\$4,677.00	\$4,677.00	\$4,677.00	\$4,720.00	\$4,855.00	\$4,810.00	\$4,858.00
11' W	\$4,760.00	\$4,760.00	\$4,760.00	\$4,760.00	\$4,760.00	\$4,803.00	\$4,938.00	\$4,976.00	\$4,983.00
12' W	\$4,838.00	\$4,838.00	\$4,838.00	\$4,838.00	\$4,838.00	\$4,888.00	\$5,026.00	\$5,038.00	\$5,071.00
13' W	\$5,174.00	\$5,174.00	\$5,174.00	\$5,174.00	\$5,174.00	\$5,224.00	\$5,357.00	\$5,372.00	\$5,394.00
14' W	\$5,259.00	\$5,259.00	\$5,259.00	\$5,259.00	\$5,259.00	\$5,309.00	\$5,389.00	\$5,414.00	\$5,460.00
15' W	\$5,342.00	\$5,342.00	\$5,342.00	\$5,342.00	\$5,342.00	\$5,389.00	\$5,442.00	\$5,497.00	\$5,550.00
16' W	\$5,384.00	\$5,384.00	\$5,384.00	\$5,384.00	\$5,384.00	\$5,417.00	\$5,454.00	\$5,525.00	\$5,580.00
17' W	\$5,394.00	\$5,394.00	\$5,394.00	\$5,394.00	\$5,394.00	\$5,429.00	\$5,487.00	\$5,555.00	\$5,620.00
18' W	\$5,427.00	\$5,427.00	\$5,427.00	\$5,427.00	\$5,427.00	\$5,487.00	\$5,537.00	\$5,595.00	\$5,650.00

Round up to next foot for accurate pricing (e.g. a 10'1" w x 8'2" h opening would be 11' w x 9' h).

HAND-HELD REMOTES (All Remotes Are Purchased Separately)			
Somfy 1 Channel Remote [Item 1810643] (Controls 1 screen.)			\$100.00
Somfy 5 Channel Remote [Item 1810645] (5 Channel controls up to 5 screens or groups of screens.)			\$125.00
Somfy 16 Channel Remote [Item 1811081] (16 Channel controls up to 16 screens or groups of screens.)			\$374.00
Somfy Situo 5 Soliris Sun Sensor 5 Channel Remote [Item 1870579] (Required to activate Sun Sensor option.)			\$206.00
HD BOTTOM BAR (Option for 7+ and 9+ Models)		OTHER ACCESSORIES	
Under 155" in Width	\$251.00	Somfy Sun & Wind Sensor [Item 9012500]	\$424.00
Over 155" in Width	\$502.00	1" x 2" Angle (For use when inside mounting the screen.)	\$90.00
BOTTOM BAR SEAL REPLACEMENT PARTS		2" x 2" Angle (For use when inside mounting the screen.)	\$208.00
Standard 1.5" Brush (Black)	\$10/Yard	Custom Frame Color (Standard RAL)	\$1,400.00
Standard 2" Brush (Black)	\$31/Yard		
4" Rubber Seal (White, Black, Gray, Bronze, Ivory, Beige)	\$6/Foot		
6" Rubber Seal (Black or Gray)	\$14/Foot		

Note: For items sold by foot or yard measurements, round up to the next even foot or yard.

Heavy-Duty Bottom Bar

Available for upgrade on 7+ and 9+ models for extra wind resistance. Standard on 10+ model.

Screen Controls

Conveniently raise and lower the screen with the push of a button on the remote; or let the automatic sun-wind sensor adjust the screen to match the weather.

SOMFY. REMOTE CONTROLS

Simultaneously operate up to 16 screens with the push of a button.

- 1 Channel controls 1 screen.
- 5 Channel controls up to 5 screens or groups of screens.
- 16 Channel controls up to 16 screens or groups of screens.

SOMFY. SUN-WIND SENSOR (Optional)

Automatically lowers up to 16 screens during intense sunlight and raises them during heavy winds.

PROFILES

Diagrams show models 6+ or 8+. Measurements are in inches.



Inside Mount

Scan the QR code to watch the installation video. These instructions describe an 'inside' or 'recessed' mount installation.



Outside Mount

Scan the QR code to watch the installation video. These instructions describe an 'outside' or 'surface' mount installation.

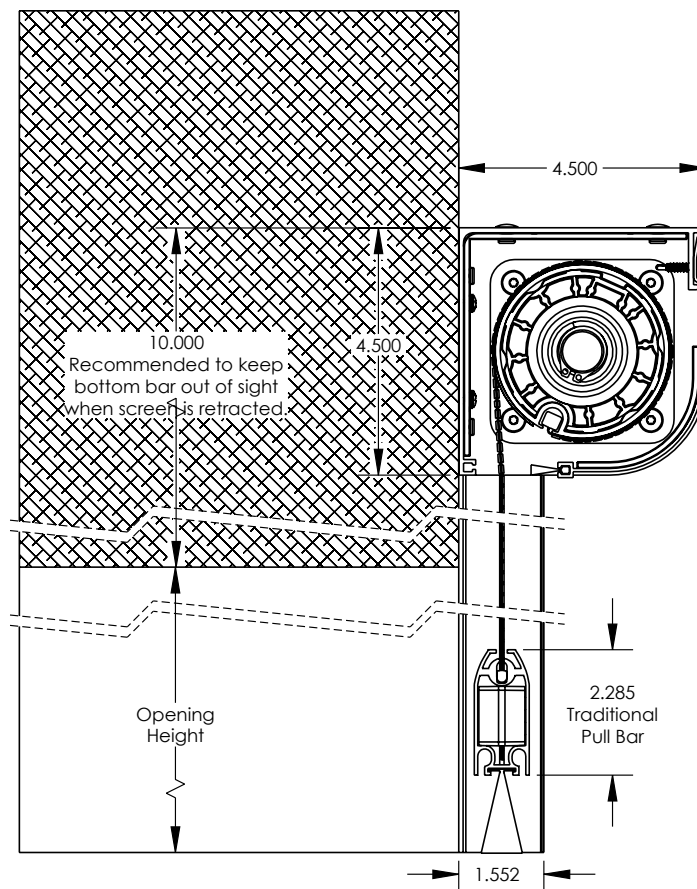
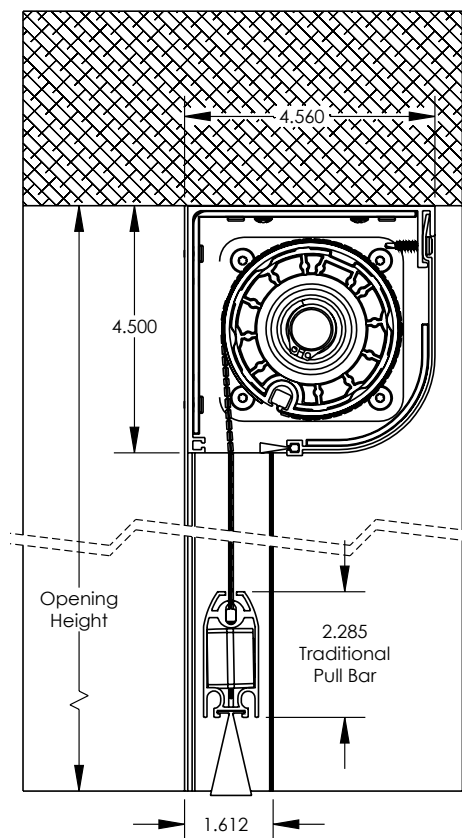

WARRANTY

Backed by the Larson Retractable Motorized Screen Warranty.

Measuring Guide:

RETRACTABLE MOTORIZED SCREEN - INSIDE MOUNT

Use these instructions to measure your opening for an inside mount motorized screen.
 Supply the final width and final height when ordering.

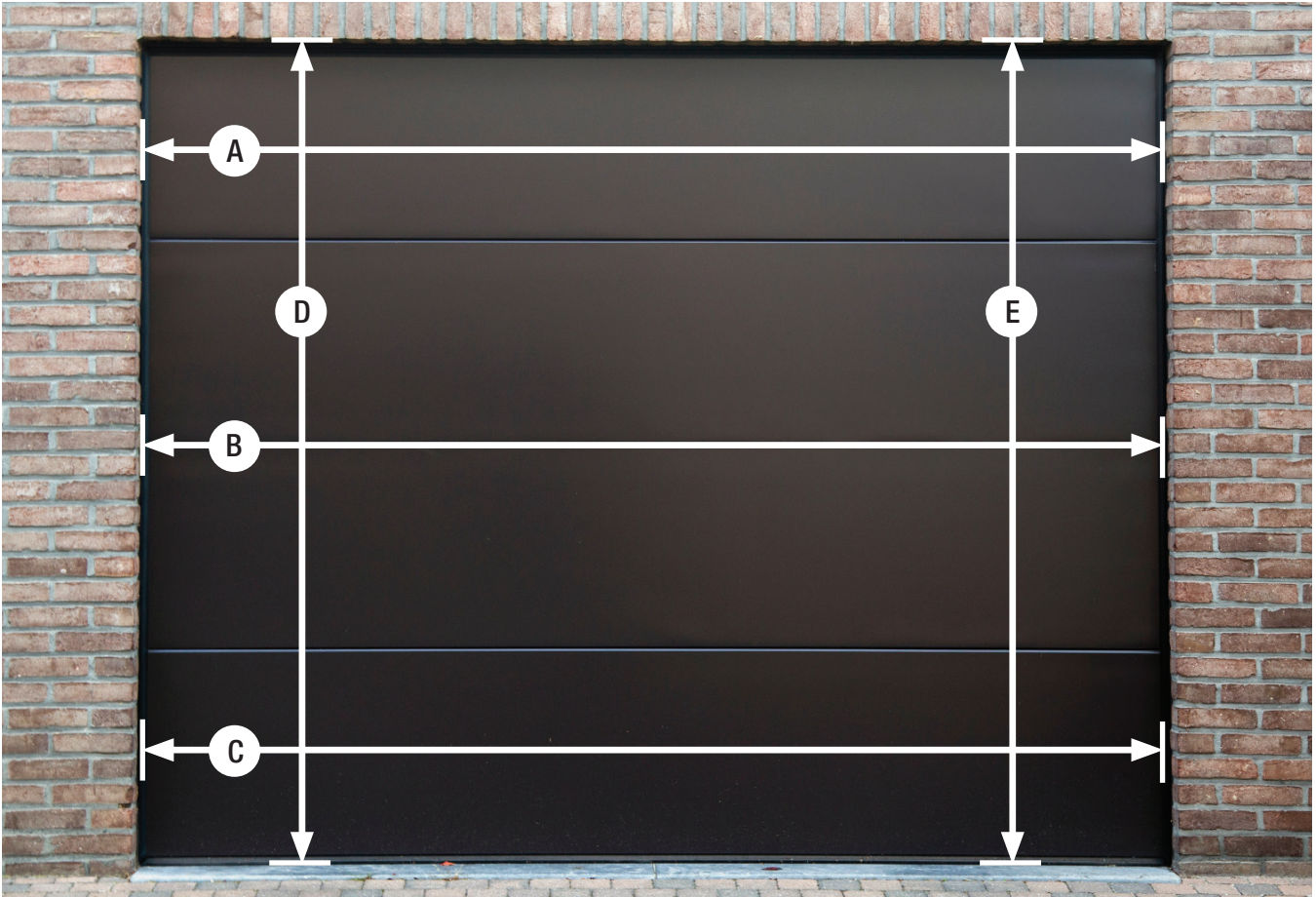

Measure distances **A**, **B** and **C** in inches and record below. Take the narrowest measurement and **subtract half an inch:**
 This is your final width.

A	Width	B	Width	C	Width	Final Width	
----------	-------	----------	-------	----------	-------	-------------	--

Measure distances **D** and **E** in inches and record below.
 The highest measurement is your final height.

D	Height	E	Height	Final Height	
----------	--------	----------	--------	--------------	--

Measuring Guide:

RETRACTABLE MOTORIZED SCREEN - OUTSIDE MOUNT

Use these instructions to measure your opening for an outside mount motorized screen.

Supply the final width and final height when ordering.

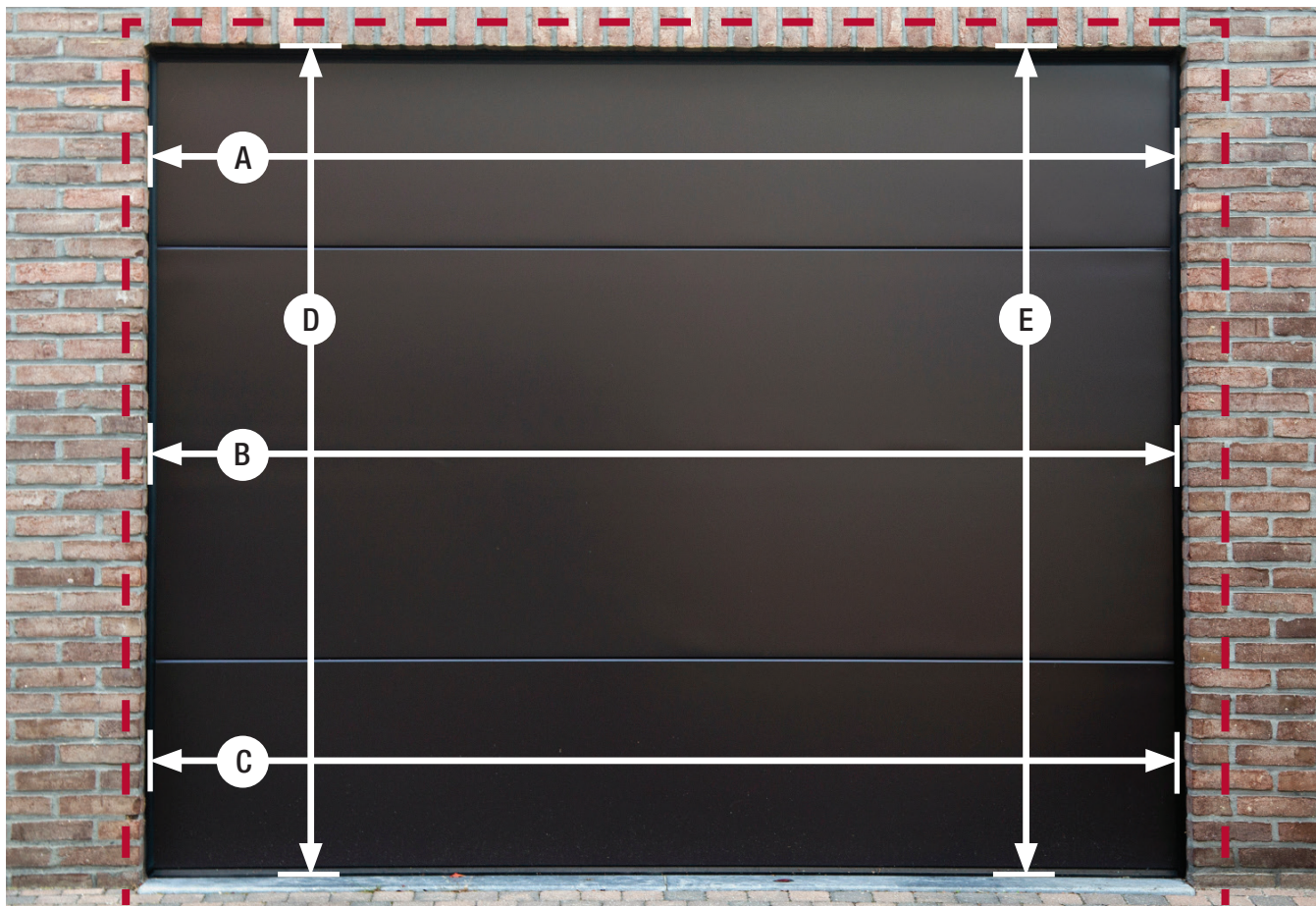

Measure distances **A**, **B** and **C** in inches and record below. Take the widest measurement and **add 5 inches:**

This is your final width.

Note: This will allow for the screen to be outside mounted without infringing on the daylight opening.

A	Width	B	Width	C	Width	Final Width	
----------	-------	----------	-------	----------	-------	-------------	--

Measure distances **D** and **E** in inches and record below. Take the highest measurement and **add 10 inches:**

This is your final height.

Note: This will allow for the housing and bottom bar to rest above the opening without infringing on the daylight opening. If there is a header, ceiling or other obstruction above the opening, you can add less than 10 inches to create the final height. However, this will cause the screen to infringe on the daylight opening.

D	Height	E	Height	Final Height	
----------	--------	----------	--------	--------------	--

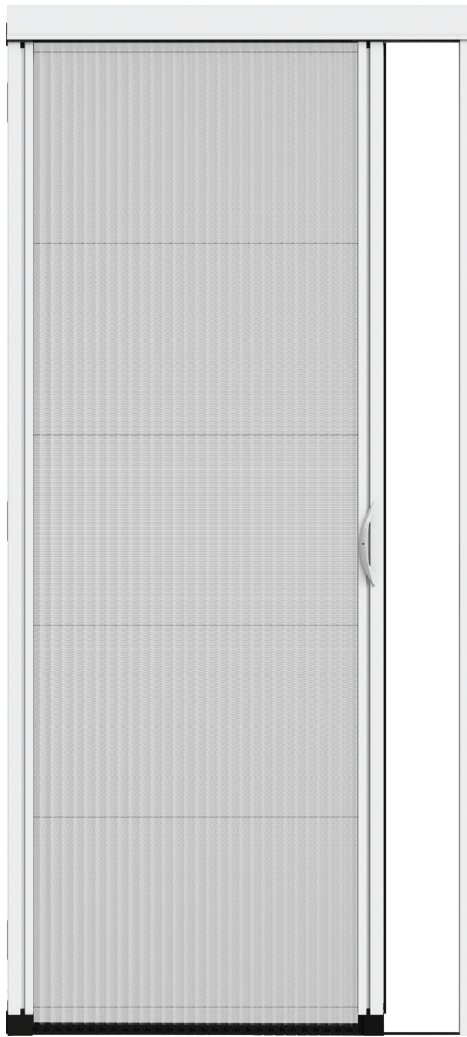

Inspire Pleated Retractable Screen Door

SEAMLESS INDOOR-OUTDOOR LIVING

Create a smooth transition between indoor and outdoor living with the Inspire pleated retractable screen door.

TOP BENEFITS

- **Fresh style.** Elegant, pleated fabric provides ventilation with refined design.
- **Unobstructed access.** The flat bottom guide installs without a runner for easy movement through the entry.
- **Custom-made ventilation.** Designed to fit single and double doors and openings up to 31-1/2' wide and over 10' high.

ADDITIONAL FEATURES

- Easily move and stop the screen at any position with one hand.
- Includes metal adjustable-height handles.
- Pre-assembled for easy installation without any cutting.

5 YEAR
LIMITED WARRANTY

5-YEAR
WARRANTY

Model Shown: IN100
White, 1E Opening

FRAME COLORS



White



Almond



Desert Tan



Brownstone



Black

PROFILES

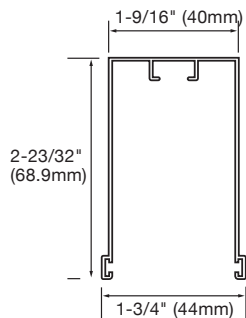

Top Profile

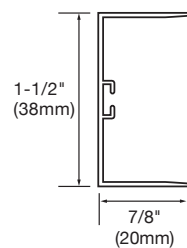

Side Profile

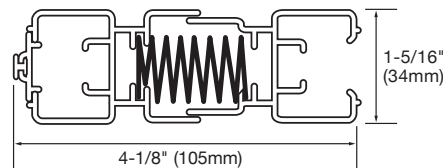

Screen Panel Profiles
with Pleated Fabric

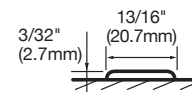

Bottom Guide

OPENING CONFIGURATIONS View from the Outside (Specify Configuration When Ordering).

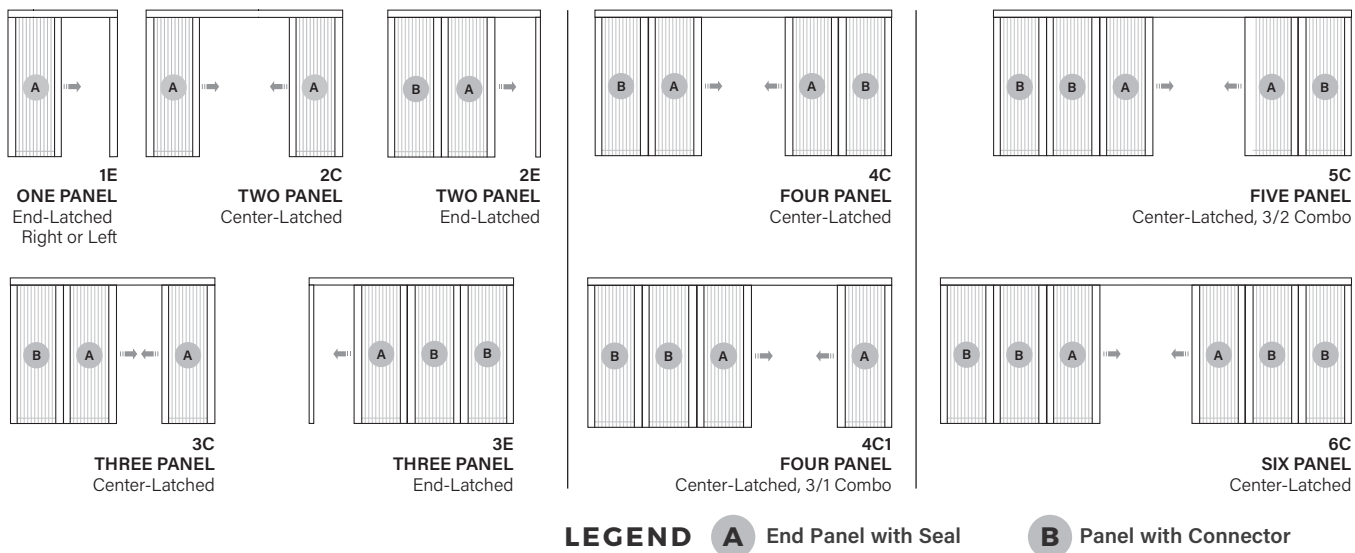

LIST PRICE

INSPIRE INT100 (Custom Sizes)			
FINISH COLOR	WIDTH PER PANEL MIN-MAX	HEIGHT PER PANEL MIN-MAX	PRICE PER PANEL *
White Almond Desert Tan Brownstone Black	up to 63"	22" - 84"	\$488.00
		84-1/8" - 96"	\$535.00
		96-1/8" - 114"	\$583.00
		114-1/8" - 125" For larger openings, call for quote.	\$794.00

SPECIFY WHEN ORDERING:

- A.** Quantity
- B.** Product Model
- C.** Frame Color
- D.** Net Screen Opening Size (W x H)
- E.** Configuration for Multi-Panel Orders

- When ordering: provide the net finished opening dimension, color, total number of desired screen panels and opening configuration as viewed from outside.
- Panels may be combined to accommodate larger openings but must be ordered using opening configurations as shown (1E - 6C). Maximum number of panels per opening: 3 from right / 3 from left = 6 TOTAL PANELS UP TO 31-1/2'.
- Screen panel height must be at least 10" higher than width.
- Custom doors have extended, variable lead times. Once placed, custom orders cannot be canceled. All other orders can be canceled within the first 24 hours.

*For double or multi options, price listed is per panel.
 Note: See your Larson seller or visit larsondoors.com for details on limited warranties and exclusions. Not intended to keep children or pets inside. Product finish colors are approximate; actual finish colors may vary.

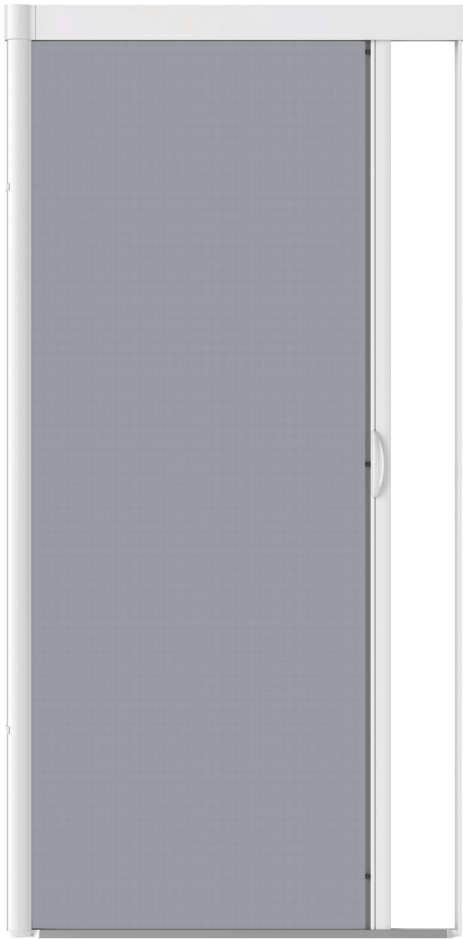

Model Shown: E100
White

Escape® Retractable Screen Door

Escape E100 (Single) E200 (Double)

AT THE THRESHOLD OF SERENITY

Enjoy the outdoors without interruption using the Escape retractable screen door.

TOP BENEFITS

- **Worry-free ventilation.** Screen provides bug-free air when you need it and retracts out of sight when you don't.
- **Slam-proof retraction.** Controlled retraction prevents the screen from slamming shut.
- **Custom-made ventilation.** Designed to fit single and double doors and openings up to 96" wide and up to 96" high.

ADDITIONAL FEATURES

- Features a durable finish and tear-resistant fabric.
- Includes metal adjustable-height handles.
- Pre-assembled for easy recessed or surface-mount installation without any cutting.

5 YEAR
LIMITED WARRANTY

5-YEAR
WARRANTY

CONFIGURATIONS

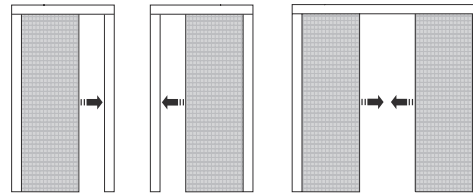

Single - E100

Double - E200

PROFILES

42.5 mm Cassette

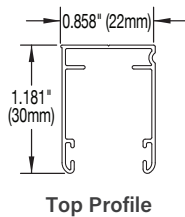
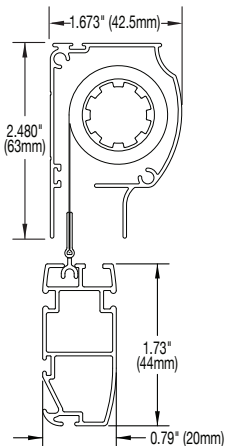

Top Profile

FRAME COLORS



White

Almond

Desert Tan

Brownstone

Black

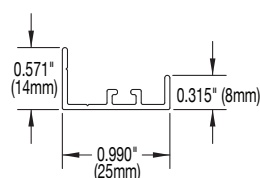

Side Profile

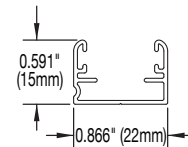

Bottom Guide

LIST PRICE

ESCAPE E100 (Custom Sizes)		
WIDTH MIN-MAX	HEIGHT MIN-MAX	PRICE
20" - 60"	36" - 84"	\$354.00
20" - 60"	84-1/8" - 96"	\$445.00

ESCAPE E200 (Custom Sizes)		
WIDTH MIN-MAX	HEIGHT MIN-MAX	PRICE
30" - 96"	36" - 84"	\$571.00
30" - 96"	84-1/8" - 96"	\$639.00

SCREEN FABRIC OPTIONS (Apply to screen pricing listed above.)		
SCREEN FABRIC OPTION	FRAME COLORS	UPCHARGE
BetterVue® Low Visibility Screen Traditional Roller Style Screens: 60" Max Width Per Panel Smooth-Glide Roller Style Screens: 66" Max Width / 36mm Cassette	Charcoal	Add 10% to List Price
17 x 20 Ultra Strength Screen 42" Max Width per Panel	Black or White	Add 15% to List Price
Heavy-Duty PetScreen® 44" Max Width per Panel	Charcoal	Add 25% to List Price
TuffScreen® No-See-Ums Fabric with Enhanced Solar Protection 56" Max. Width Per Screen Panel	Charcoal	Add 25% to List Price

AVAILABLE THRESHOLD TRANSITIONS (When ordered with the door screen.)		
SCREEN FABRIC OPTION	FRAME COLORS	UPCHARGE
(Larson recommends that you deduct 1/16" from height of the net screen opening when using a transition.)		
Narrow Threshold Transition with End Caps	Silver or Bronze	\$1.00 Per Lineal Inch of the Width Measurement
Medium Threshold Transition with End Caps	Silver or Bronze	\$1.00 Per Lineal Inch of the Width Measurement
Rubber "L" Bug Seal For Use in the Back Channel of the Screen Cassette (not installed)		\$0.02 Per Lineal Inch of the Width Measurement
No Speed Reducer (Brake)		Deduct \$10 from List Price
Wind Pile Weather Strip In The Top Guide Rail		No Additional Charge
Sloped Wedge Shim (12" each) For Use With Traditional 15mm x 22mm Bottom Guide		\$4.00/ea.
Sloped Wedge Shim (12" each) For Use With Narrow Threshold Transition		\$4.00/ea.
Sloped Wedge Shim (12" each) For Use With Medium Threshold Transition		\$4.00/ea.
(Larson recommends that you deduct 1/8" from height of the net screen opening when using sloped wedge shims.)		

THRESHOLD TRANSITION KITS (2 pieces plus end caps per each kit.)				
TRANSITION STYLE	DESCRIPTION	PART # SILVER FINISH	PART # BRONZE FINISH	LIST PRICE
Narrow	2 Pieces 40" Long	06-01120-0-0	06-01120-1-2	\$32.00
	2 Pieces 72" Long	06-12010-0-0	06-12010-1-2	\$43.00
Medium	2 Pieces 40" Long	06-01130-0-0	06-01130-1-2	\$40.00
	2 Pieces 72" Long	06-12020-0-0	06-12020-1-2	\$52.00

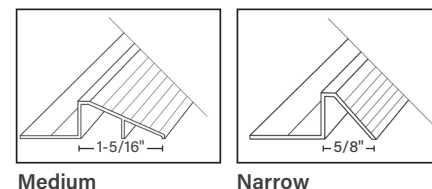

SPECIFY WHEN ORDERING:

- Quantity
- Product Model (E100 or E200)
- Frame Color
- Mounting Type
 - Recess/Inset Mounted or
 - Surface/Face Mounted
- Net Screen Opening Size (Width x Height)
- Options (Specify any desired options or alternate screen fabric)

- Custom doors have extended, variable lead times. Once placed, custom orders cannot be canceled. All other orders can be canceled within the first 24 hours.

Measuring Guide:

SINGLE PANEL DOOR SCREENS

Applies only to Escape® and Inspire® inside mount applications.

Measuring a typical hinged door for the net screen opening dimensions.

Begin by deciding where best to position the screen. The opening must be plumb, level and square and, the bottom guide of the retractable screen must rest on a flat, level and solid surface. Make any needed adjustments to the opening (or plan and allow for shimming) before measuring for the screen. Determine the **net screen opening dimension** (width x height) as measured from the outermost edges of where the retractable screen will rest. Screens are then made to fit these dimensions. Manufacturing tolerances are **plus or minus 1/16"**. We recommend that with inside the frame installations (**options A or B**) that you **deduct an additional 1/16"** from the width and height dimensions that you submit in order to assure that the screen is not too tight in the opening during installation. If you plan on using shims or threshold transitions, be sure to also deduct appropriately for these. See the product model catalog pages and installation instructions for more detail.

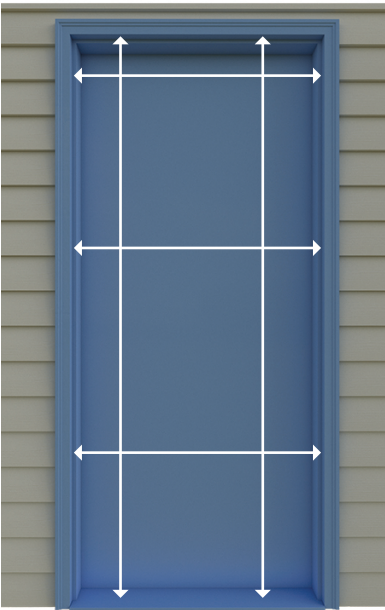

COMMON INSTALLATIONS

- OPTION A** Inside the Frame (Recess/Inset Mounted)
- OPTION B** Fully Inside the Frame (Recess/Inset Mounted)
- OPTION C** Outside the Frame (Surface/Face Mounted)

RECORD FINAL NET SCREEN OPENING DIMENSIONS

W _____

H _____

(If using installation option A or B, **deduct 1/16"** from the width and height to order).

OPTION A (Recommended)

INSIDE THE FRAME INSTALLATION
Recess Mounted at the Brickmould

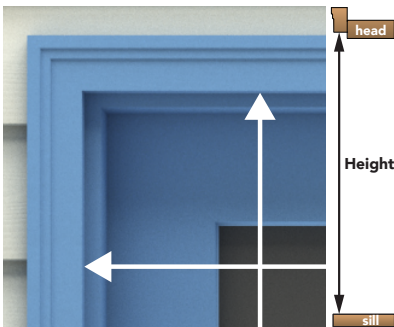
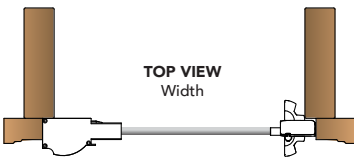

OPTION B

INSIDE THE FRAME INSTALLATION
Fully Inside the Master Frame

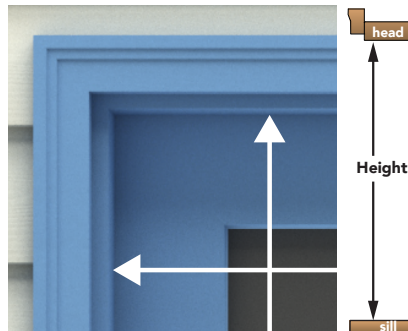
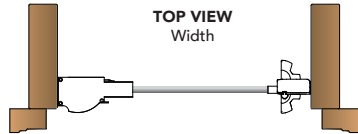

OPTION C

OUTSIDE THE FRAME INSTALLATION
Surface/Face Mounted

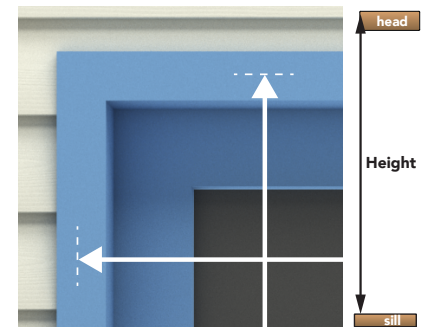
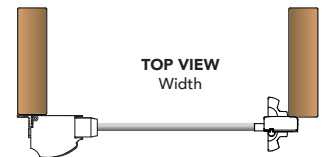

Measuring Guide:

DOUBLE PANEL DOOR SCREENS

Applies only to Escape® and Inspire® inside mount applications.

Measuring a typical hinged double door for the net screen opening dimensions.

Begin by deciding where best to position the screen. The opening must be plumb, level and square and, the bottom guide of the retractable screen must rest on a flat, level and solid surface. Make any needed adjustments to the opening (or plan and allow for shimming) before measuring for the screen. Determine the **net screen opening dimension** (width x height) as measured from the outermost edges of where the retractable screen will rest. Screens are then made to fit these dimensions. Manufacturing tolerances are **plus or minus 1/16"**. We recommend that with inside the frame installations (**options A or B**) that you **deduct an additional 1/16"** from the width and height dimensions that you submit in order to assure that the screen is not too tight in the opening during installation. If you plan on using shims or threshold transitions, be sure to also deduct appropriately for these. See the product model catalog pages and installation instructions for more detail.

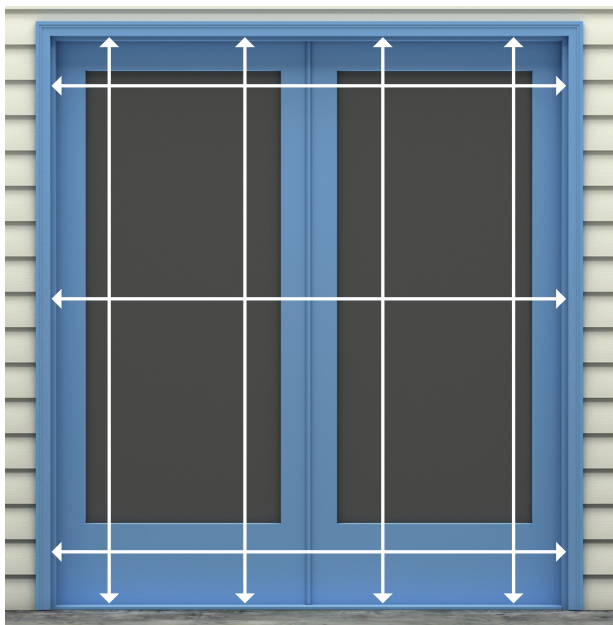

COMMON INSTALLATIONS

- OPTION A** Inside the Frame (Recess/Inset Mounted)
- OPTION B** Fully Inside the Frame (Recess/Inset Mounted)
- OPTION C** Outside the Frame (Surface/Face Mounted)

RECORD FINAL NET SCREEN OPENING DIMENSIONS

W _____
 H _____

(If using installation option A or B, **deduct 1/16"** from the width and height to order).

OPTION A (Recommended)

INSIDE THE FRAME INSTALLATION
 Recess Mounted at the Brickmould

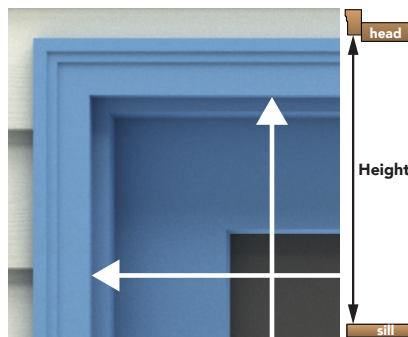
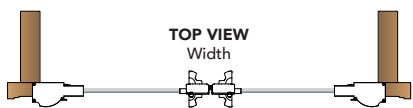

OPTION B

INSIDE THE FRAME INSTALLATION
 Fully Inside the Master Frame

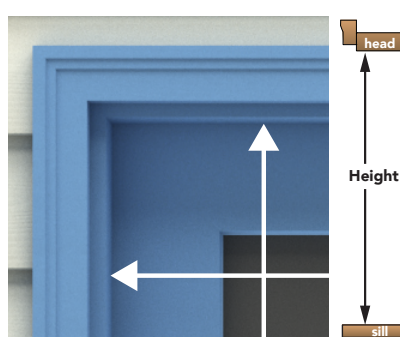
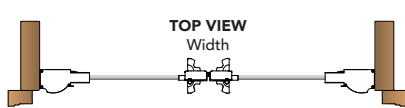

OPTION C

OUTSIDE THE FRAME INSTALLATION
 Surface/Face Mounted

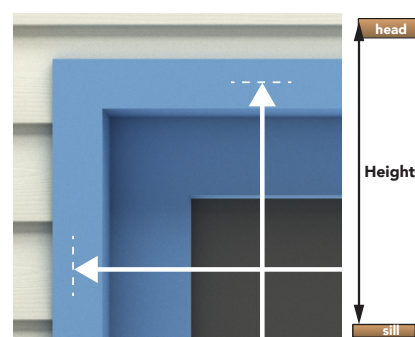
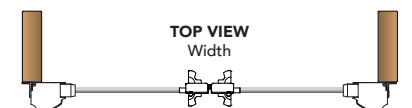

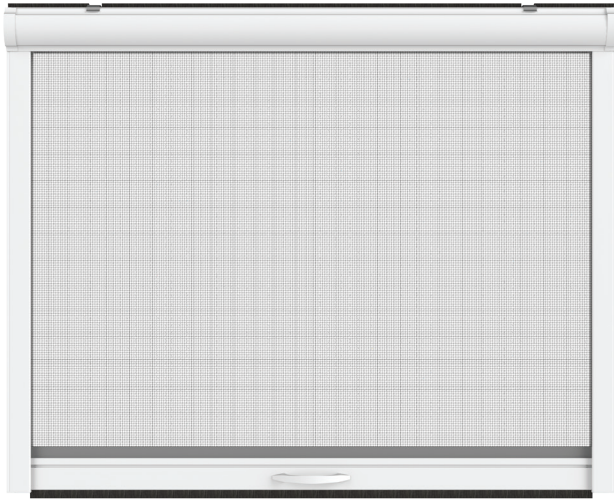

NatureVue Retractable Window Screen

NatureVue NV100

FRESH AIR IS ALWAYS IN REACH

Transform every window into an opportunity for ventilation using the NatureVue retractable window screen.

5 YEAR
LIMITED WARRANTY

5-YEAR
WARRANTY

TOP BENEFITS

- **Worry-free ventilation.** Screen provides bug-free air when you need it and retracts out of sight when you don't.
- **Custom-made ventilation.** Designed to window openings up to 72" wide and up to 90" high.

ADDITIONAL FEATURES

- Features a durable finish and BetterVue® fabric.
- A speed reducer provides controlled vertical retraction.
- Thick insect pile seals out insects.
- Includes a metal handle.
- Designed for easy recessed or surface mount installation.

FRAME COLORS



LIST PRICE

NATUREVUE NV100			
FINISH COLOR	WIDTH MIN-MAX	HEIGHT MIN-MAX	BETTERVUE SCREEN
White	16-1/2" - 60"	12" - 72"	\$168.00
Almond	16-1/2" - 60"	72-1/8" - 90"	\$198.00
Desert Tan	60-1/8" - 72"	12" - 72"	\$190.00
Brownstone	60-1/8" - 72"	72-1/8" - 90"	\$243.00
Black	60-1/8" - 72"	72-1/8" - 90"	\$243.00

Measuring Guide:

RETRACTABLE WINDOW SCREEN

Measuring for the net screen opening dimensions of a retractable window screen.

There are many different window frame designs and operation types, each with their own mounting requirements. Before measuring, determine the screen placement that will provide the best stability, operation and appearance. Window frame stylization and decorative mouldings may require that you install shims so that the screen can be installed in a stable, plumb and level manner.

Begin by determining the **net screen opening dimension** (width x height) as measured from the outermost edges of where the retractable screen will rest (**see image A**). Screens are then made to fit the net screen opening dimensions. We recommend **deducting an additional 1/16"** from the width and height dimensions in order to assure the screen is not too tight in the opening during installation.

All window screen orders **default to inside the frame (recessed) mounting** unless specifically noted that the screen will be used for **outside (surface) mounting**. When outside (surface) mounting a window screen, please note the type of mounting and then provide the net screen opening dimensions as defined as:

- Width: The tip-to-tip measurement of the final assembled screen cassette (**see image A**).
- Height: The measurement from the outermost edge where the screen cassette will rest to the tip of the side guide rail end cap (**see image A**).

The following illustrations show how to measure the net screen opening dimension of a retractable window screen.

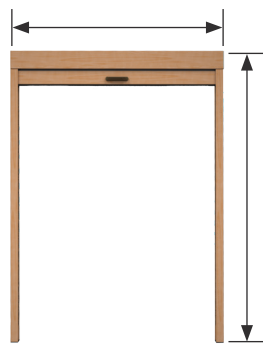

Image A

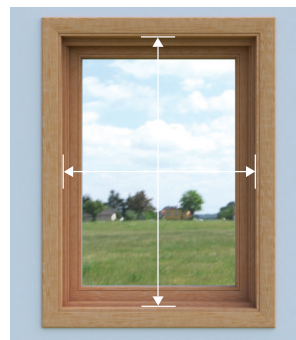

Image B

The NatureVue retractable window screen can be installed in one of two orientations so that the protruding area of the cassette faces away (most typical – **see image C**), or toward the window frame (**see image D**). The most typical way is for the protruding area of the cassette to face away from the frame. However, it can be useful to reverse the orientation of the cassette for aesthetic reasons or to avoid existing window hardware. For further detail, refer to the Larson installation instructions for the retractable window screen model.



Image C



Image D

Guardsman Collection

TRADITIONAL COMFORT – ADVANCED SECURITY

The Guardsman Collection offers a complete line of steel security doors engineered to protect what matters most without sacrificing style and ease of use.

The welded tubular steel frame and three-piece tempered safety glass system provide superior strength, and the anti-removal vault pin and heavy-duty hinges add reinforced protection. Interchangeable insect screens are sold separately for seasonal venting.



DURABLE FRAME

Welded tubular steel frame for superior strength.



SAFETY & SECURITY

Anti-removal vault pin for reinforced protection.



REINFORCED HINGES

Heavy-duty 7" hinges for a secure mount.



Model Shown: El Dorado 920-28
Black Frame



Guardsman Collection Security Storm Doors

FRAME COLORS

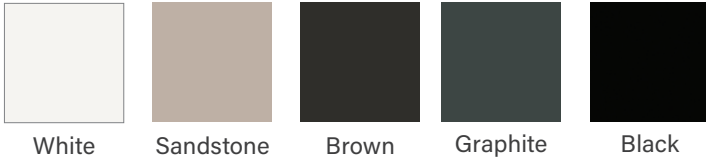

AVAILABLE MODELS

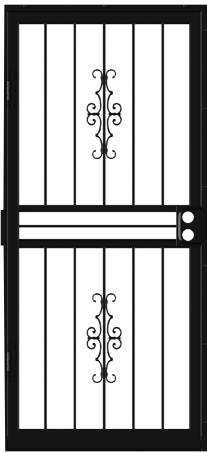

Courtyard
920-20



Garden View
920-21



Geneva
920-24

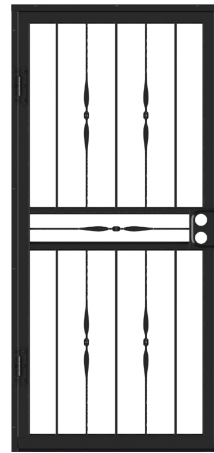

El Dorado
920-28

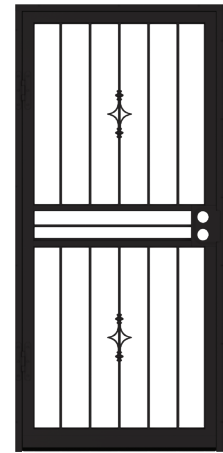

SoHo
920-36



Model Shown: Garden View 920-21
White Frame

LIST PRICE

MODEL	SIZE	WHITE	BLACK	SANDSTONE	BROWN	GRAPHITE
Courtyard 920-20	32" x 81" 36" x 81"	\$405.00		\$682.00		
Garden View 920-21		\$498.00		\$726.00		
Geneva 920-24		\$405.00		\$682.00		
El Dorado 920-28		\$480.00		\$781.00		
SoHo 920-36		\$446.00		\$781.00		

SINGLE CUSTOM* 			
MODEL	SIZE		
	REGULAR CUSTOM W: 30" - 36" H: 76" - 84"	OVERSIZE CUSTOM W: 36-1/8" - 42" H: 76" - 84"	OVERSIZE PLUS CUSTOM W: 30" - 42" H: 84-1/8" - 96"
Courtyard 920-20	\$832.00	\$878.00	\$924.00
Garden View 920-21	\$855.00	\$901.00	\$947.00
Geneva 920-24	\$832.00	\$878.00	\$924.00
El Dorado 920-28	\$901.00	\$947.00	\$1,040.00
SoHo 920-36	\$901.00	\$947.00	\$1,040.00
DOUBLE CUSTOM* 			
Courtyard 920-20	\$1,663.00	\$1,756.00	\$1,848.00
Garden View 920-21	\$1,709.00	\$1,802.00	\$1,894.00
Geneva 920-24	\$1,663.00	\$1,756.00	\$924.00
El Dorado 920-28	\$1,802.00	\$1,894.00	\$2,079.00
SoHo 920-36	\$1,802.00	\$1,894.00	\$2,079.00

TOO MANY KEYS?

Provide your own hardware so you can open your entry and security doors with the same key.

Select standard entry door hardware with a 2-3/8" backset and a 2-1/8" hole diameter.



*Custom doors have extended, variable lead times. Once placed, custom orders cannot be canceled.
 Note: Larson reserves the right to alter or discontinue any model, specification, warranty or price without notice. Product finish colors are approximate; actual finish colors may vary. See your Larson seller or visit larsondoors.com for details on limited warranties and exclusions.

Lock Box Location

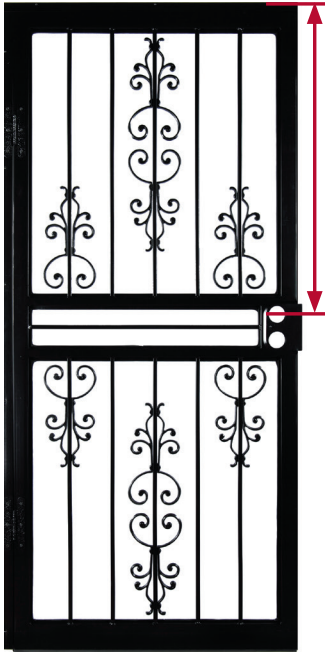

STANDARD:

Hardware location for Guardsman doors are figured from the top of the opening down to the center of the lever/knob which is mounted in the top hole of the lock box. Based on a standard 81" door this measurement is 38".

CUSTOM:

When ordering, indicate the distance from the top of the door opening to the center of the lock box.

Allowable location is center of the door based on the centered ordered opening height + or - 12".

Example: Opening Height: 83"
Center of Door: 41-1/2"

Maximum Height: 53-1/2" ($41-1/2" + 12" = 53-1/2"$)

Minimum Height: 29-1/2" ($41-1/2" - 12" = 29-1/2"$)

ACCESSORY ADD-ONS*

PRODUCT OPTIONS	FRAME COLORS & SIZES	ADD PER UNIT
Custom Lock Box Heights Provide measurements when ordering - see above.	Order Custom Sizes	\$77.00
Mail Slot - Silver or Brass Finish Double Doors: mail slot installed on active door.	Order Custom Sizes	\$239.00
Insect Screen Half screen fits top or bottom.	White, Black - Standard Sizes only (Single Door)	\$55.00
	All Colors - Custom Sizes (Single Door)	\$66.00
	Double Door - 2 screens	\$132.00

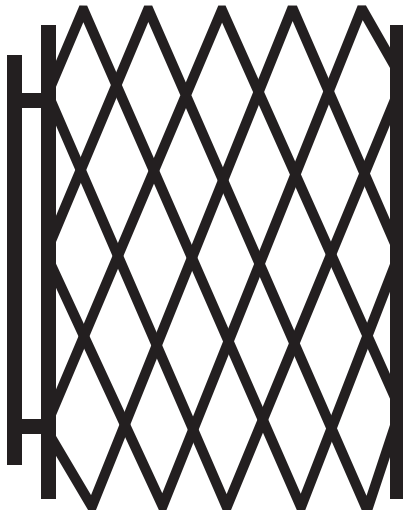

Folding Gate

Sturdy construction with reinforced rivets. Adjusts to openings up to 52" wide. Hinged to swing out. Two-year warranty covers gate finish.

Accepts padlocks (not included).

LIST PRICE

MODEL	SIZE	BLACK
Folding Security Gate 915-48	W: 12" - 52" H: 79"	\$164.00

Measuring Guide:

SECURITY STORM DOORS

Use the diagram below to record your measurements as shown. If the width measurements vary, record the smallest measurement.

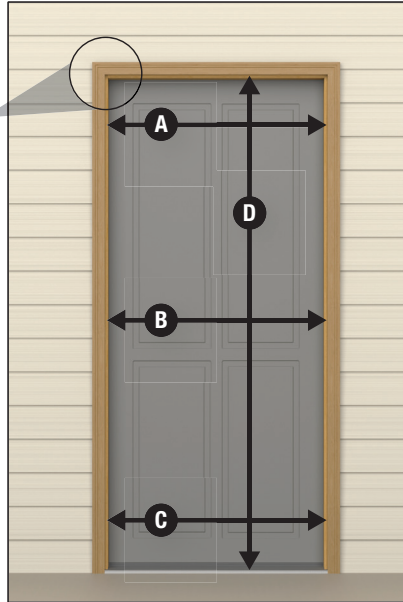

RECORD MEASUREMENTS

A	Width
B	Width
C	Width
D	Height



RECESS MOUNT

The rails mount inside the opening and require a 1" wide by 1" deep mounting surface.

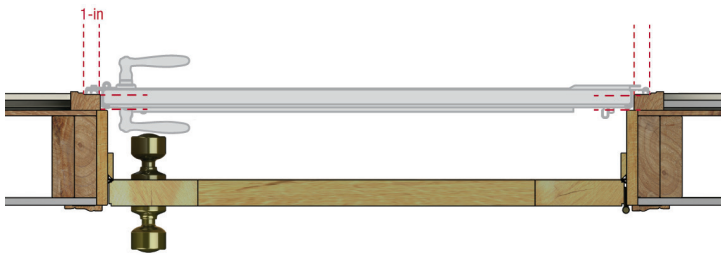

Construction styles may vary.

PRE-HINGED FOR EFFORTLESS INSTALLATION

Select **L** (left-hinge) or **R** (right-hinge) as viewed from outside.

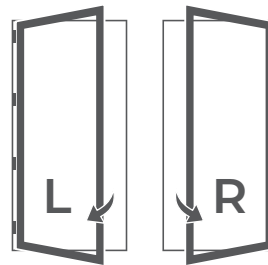

SPECIFY WHEN ORDERING:

- A. Model Number
- B. Color
- C. Required Opening Size (width x height).
- D. Hinge Side (LH or RH)

STANDARD DOOR WIDTH	OPENING WIDTH RANGE	OPENING HEIGHT RANGE
32"	31-7/8" - 32-3/8"	79-3/4" to 81"
36"	35-7/8" - 36-3/8"	

*Door Options (excluding half screen) are non retrofittable and must be ordered with the door.

Note: Larson reserves the right to alter or discontinue any model, specification, warranty or price without notice. Product finish colors are approximate; actual finish colors may vary. See your Larson seller or visit larsondoors.com for details on limited warranties and exclusions.

Guardsman Collection

Round Top Styles

The Guardsman Collection features two styles in a round top configuration. These doors feature tempered safety glass and include a pneumatic closer and wind chain. Unlike standard security doors, round top doors require more complex installation; professional installation is recommended.

Delivery: Expect extended lead times from the day the order is placed and template approved.

Installation: Framing includes three pieces and requires a professional installation for on-site adjustments.

FRAME COLORS

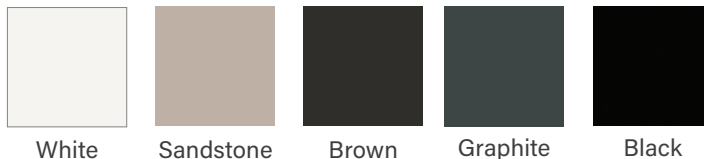

Fullview Model

PRODUCT FEATURES

- Fixed glass panel.
- Mortise style lock included.
- Width: 30"-42", Height: 76"-96"



Double key lock cylinder standard.
Thumb turn key optional with Brass and Antique Brass. Specify when ordering.

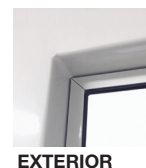
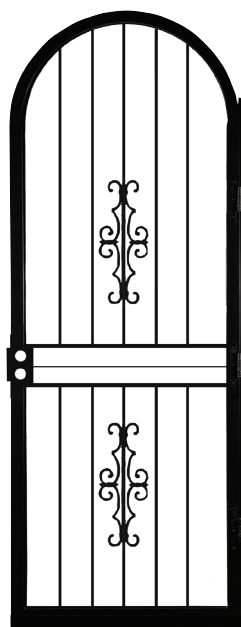

Courtyard Model

PRODUCT FEATURES

- Security bars with 3 fixed glass panels.
- Reinforced lock box.
- Bottom insect screen sold separately.
- Width: 30"-42", Height: 76"-96"



TOO MANY KEYS?

Provide your own hardware so you can open your entry and security doors with the same key.

Select standard entry door hardware with a 2-3/8" backset and a 2-1/8" hole diameter.

Measuring Guide:

ROUND TOP GUIDELINES

For pricing, complete this form and email to quotes@larsondoors.com or FAX to 800-888-9006.

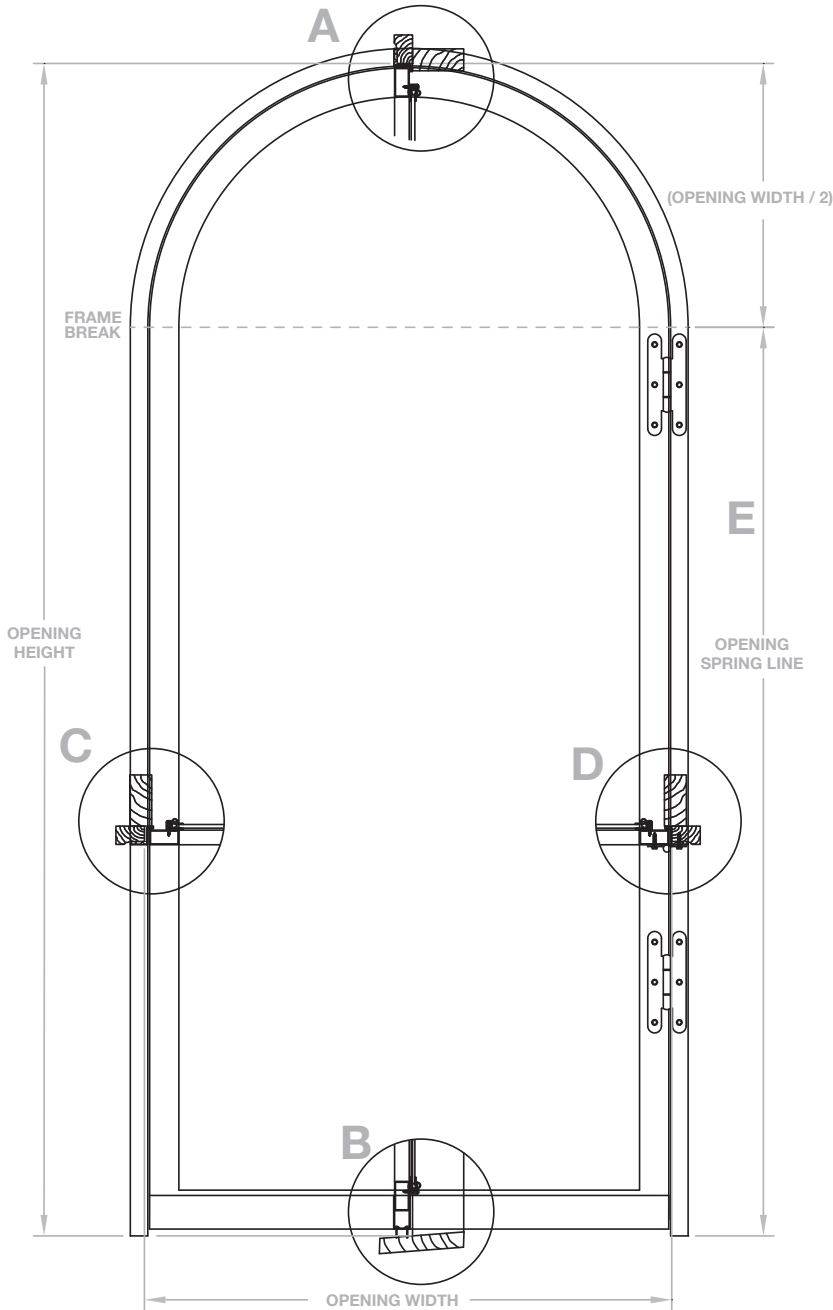

NOTES:

1. Hinging:

as viewed from outside

 Left-Hinge

 Right-Hinge

2. Rough Opening Height (A/B):

3. Rough Opening Width (C/D):

4. Rough Opening Spring Line (E):

A squared 1" x 1" brickmould is required for installation. Any shape other than a true half round will require an opening template.

DEALER _____

CONTACT _____

ADDRESS _____

EMAIL _____

Note: Larson reserves the right to alter or discontinue any model, specification, warranty or price without notice. Product finish colors are approximate; actual finish colors may vary.

Retail Hardware

Pneumatic Door Closers

Designed for outswing metal, wood or composite storm and screen doors.



CH1020306

CH1040306

CH1030306



White

Black

HEAVY-DUTY CLOSERS

CH1020306 & CH1020506

(Case of 6)

Measuring 12-5/8" center hole to center hole and 1-1/2" in diameter, the heavy-duty closer is built for single-closer use on medium- and heavy-weight doors. Includes mounting brackets and attaching hardware.

STANDARD-DUTY CLOSERS

CH1040306 & CH1040506

(Case of 6)

Measuring 12-5/8" center hole to center hole and 1-1/4" in diameter, the standard-duty closer is built for single-closer use on light- and medium-weight doors or for dual-closer use on heavy doors. Includes mounting brackets and attaching hardware.

STANDARD-DUTY CLOSERS WITH HOLD-OPEN FEATURE

CH1030306 & CH1030506

(Case of 6)

Measuring 12-5/8" center hole to center hole and 1-1/4" in diameter, the standard-duty closer is built for single-closer use on light- and medium-weight doors or for dual-closer use on heavy doors. Hold-open feature offers a hands-free way to keep the door open. Includes mounting brackets and attaching hardware.

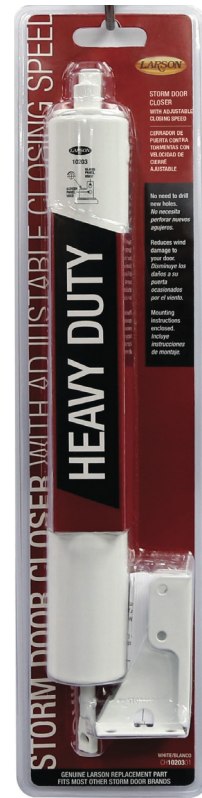

PART #	DESCRIPTION	FINISH	CASE QUANTITY (6 PER CASE)	LIST PRICE
CH1020306	Heavy-Duty Closer	White	1	\$73.00
CH1020506	Heavy-Duty Closer	Black	1	
CH1040306	Standard-Duty Closer	White	1	\$60.00
CH1040506	Standard-Duty Closer	Black	1	
CH1030306	Standard-Duty Closer with Hold-Open Feature	White	1	\$109.00
CH1030506	Standard-Duty Closer with Hold-Open Feature	Black	1	

Retail Hardware Handlesets

Includes detailed instructions, mounting templates and all required installation hardware.



REVERE MORTISE HANDLESETS CH3040706, CH3041706 & CH3045706 (Case of 6)

This locking mortise handleset fits doors 1-1/8" to 2" thick with a 5/8" by 5-3/4" mortise hole. Comes with reversible levers for right- or left-handing.

PART #	FINISH	CASE QUANTITY (6 PER CASE)	LIST PRICE
CH3040706	Brass	1	\$524.00
CH3041706	Nickel	1	
CH3045706	Aged Bronze	1	



M2 MORTISE HANDLESETS CH3020706, CH3021706 & CH3025706 (Case of 6)

Made exclusively for Larson doors, this handleset fits doors 3/4" thick with a 9/16" by 1-1/8" mortise hole. Includes the added security of a keyed lock.

PART #	FINISH	CASE QUANTITY (6 PER CASE)	LIST PRICE
CH3020706	Brass	1	\$399.00
CH3021706	Nickel	1	
CH3025706	Aged Bronze	1	



GEORGIAN LEVER SURFACE MOUNTED HANDLESETS CH3010306 & CH3010706 (Case of 6)

This classic Georgian surface mount handleset uses a single-piece face plate to replace existing hardware on most doors. Fits doors 3/4" to 1-1/8" thick with a 1-3/4" hole space.

PART #	FINISH	CASE QUANTITY (6 PER CASE)	LIST PRICE
CH3010306	White	1	\$166.00
CH3010706	Brass	1	\$199.00

Note: Shipping and handling charges may apply. Requests to ship direct to a homeowner are subject to a shipping charge. Includes all products. Larson reserves the right to alter or discontinue any model, specification, warranty or price without notice. Product finish colors are approximate; actual finish colors may vary.

Retail Hardware Handlesets

Includes detailed instructions, mounting templates and all required installation hardware.



EURO PUSH-BUTTON SURFACE MOUNTED HANDLESETS

CH2000306 & CH2000506
(Case of 6)

The elegant Euro Push-Button handleset fits doors 3/4" to 1-1/4" thick with a standard hole spacing of 1-3/4". Includes a color-matched surround plate and an interior paddle latch with a No Lockout feature.

PART #	FINISH	CASE QUANTITY (6 PER CASE)	LIST PRICE
CH2000306	White	1	\$119.00
CH2000506	Black	1	



HEAVY-DUTY PUSH-BUTTON SURFACE MOUNTED KEYED HANDLESETS

CH2010306
(Case of 6)

This heavy-duty push-button handleset fits doors 3/4" to 1-1/4" thick with a standard hole spacing of 1-3/4". Includes a color-matched surround plate, keyed lock and interior paddle latch with a No Lockout feature.

PART #	FINISH	CASE QUANTITY (6 PER CASE)	LIST PRICE
CH2010306	White	1	\$183.00



EURO LIFT LEVER SURFACE MOUNTED HANDLESETS

CH4010306 & CH4010506
(Case of 6)

The smooth-action Euro Lift Lever handleset fits doors 3/4" to 1-1/4" thick with a standard hole spacing of 1-3/4". Includes a color-matched surround plate and interior paddle latch with a No Lockout feature.

PART #	FINISH	CASE QUANTITY (6 PER CASE)	LIST PRICE
CH4010306	White	1	\$119.00
CH4010506	White	1	

Retail Hardware

Wind Chains

Wind chains help to absorb some of the shock if the door suddenly blows open from high winds. If installed properly, this can potentially minimize damage to door closers, closer brackets, and door hinges. Allows the door to open a full 90-degrees.



STORM DOOR CHAIN CH9010106 & CH9010506 (Case of 6)



PART #	FINISH	CASE QUANTITY (6 PER CASE)	LIST PRICE
CH9010106	Zinc	1	\$34.00
CH9010506	Black	1	

Door Sweeps

Includes two 38" long double-sweep pieces. Can be used to replace single sweeps for an even tighter seal. Fits all Larson storm doors manufactured after 2000. Not compatible with wood core doors with composite expanders.



STORM DOOR SWEEP CH9030506 (Case of 6)

PART #	FINISH	CASE QUANTITY (6 PER CASE)	LIST PRICE
CH9030506	Black	1	\$60.00



Replaces these profiles:

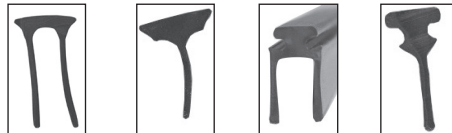

Parts & Accessories

Replacement Closer Kits & Miscellaneous Accessories

REPLACEMENT CLOSER KITS				
PART #	DESCRIPTION	COLOR		LIST PRICE
202655xx	V920 Closer	White	Almond	\$37.00
		Sandstone	Brown	
202665xx	V150 Closer	White	Almond	\$39.00
202562xx	V920 Double Closer	White	Black	\$49.00
		Sandstone	Brown	
		Almond		
202789xx	Two-Closer System 1 Hold-Open 1 Standard Closer	White	Black	\$60.00
		Sandstone	Brown	
		Almond	Graphite	



V920 CLOSER



V150 CLOSER

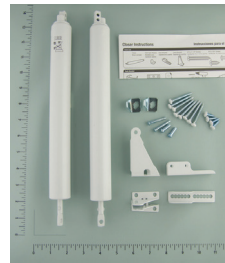

V920 DOUBLE CLOSER

MISCELLANEOUS ACCESSORIES	
PRODUCT	LIST PRICE
Hinge Rail	\$53.00
Latch Rail	\$49.00
Drip Cap	\$33.00
Retainer Strip - Fullview	\$33.00
Aluminum Color-Matched Expander with Sweep	\$45.00
White Vinyl Expander with Sweep	\$31.00
Touch Up Paint Bottle	\$23.00
Touch Up Paint Spray	\$27.00
Pet Flap - Medium #202821 8x12 (149PV, 146PV)	\$35.00
Pet Flap - Large #202746 10x17 (370-79, 360-79)	\$41.00
Pet Flap - XL #202728 14x23 (370-78)	\$64.00

EXPANDER SPLINES

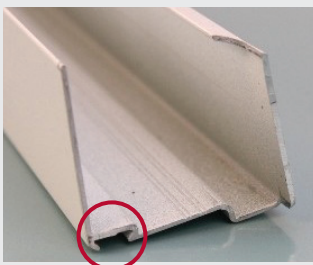





PART #	2029498R	2029496R	2023197R	2023196R	202313	33923
LIST PRICE	\$20.00					\$13.00

Parts & Accessories

Glass & Screen Inserts

When placing order, please provide door color, size and model or tip-to-tip measurement of insert.

Registration number required for proper size and pricing.

GLASS INSERTS			
PRODUCT	PART #	GLASS TYPE	LIST PRICE
Fullview Fixed Light	 Specify Model	Plain	\$119.00
	Specify Model	Decorative	\$185.00
Fullview Built-In Pet Door (149 Models Only)	 087190xxX	Pet Door	\$252.00
Fullview Low-E	 Specify Model	Low-E Glass	\$174.00
Highview Fixed Light	 Specify Model	Plain	\$82.00
Midview	Specify Model	Single-Vent	\$70.00
Highview		Multi-Vent	

SCREEN INSERTS			
OPTION	FULLVIEW	MIDVIEW	HIGHVIEW
Multi-Vent 1-Lite Screens		\$152.00	\$60.00
Single-Vent Screens	\$64.00	\$60.00	\$60.00

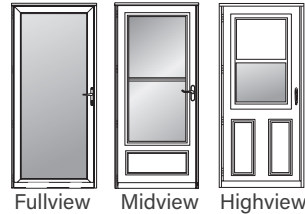

RETRACTABLE SCREEN REPLACEMENT KIT	
Classic Elegance / Wood Core	\$53.00

Contains new screen tube with screen and spring unit and easy-to-follow installation instructions.

SCREEN AWAY / EASY VENT GLASS INSERTS			
OPTION	FULLVIEW	MIDVIEW	HIGHVIEW
Clear Glass (146 Models)			
Top Glass with Screen	\$88.00		
Bottom Clear Glass (Pet Door Not Included)	\$72.00	\$70.00	
Low-E Glass (146 Models)			
Top Low-E Glass with Screen	\$115.00		
Low-E Bottom Glass	\$97.00		
Easy Vent Pet Models			
Top Glass with Screen	\$88.00		
Bottom Clear Glass with Pet Door (Available for Use on 146)	\$236.00		
Easy Vent Bevel Glass (146 Models)			
Top Bevel Glass with Screen	\$115.00		
Bottom Bevel Glass			

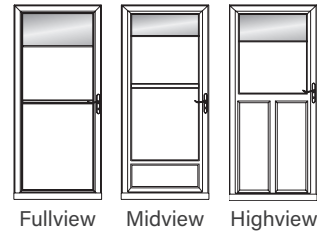







Miscellaneous replacement parts call Larson at 1-800-334-1328.

Note: Shipping and handling charges may apply. Requests to ship direct to a homeowner are subject to a shipping charge. Includes all products. Larson reserves the right to alter or discontinue any model, specification, warranty or price without notice. Product finish colors are approximate; actual finish colors may vary.



Parts & Accessories



Exterior/Interior Handlesets with Closer Kits

HANDLESET	SERIES/MODEL			PART #	COLOR/FINISH	LIST PRICE
 <p>Push-Button with Keyed Lock and FlexGuard Closer <i>Includes Flexguard Closers</i></p>	Reversa Screen 370-50			#20269103	White	\$60.00
				#20269104	Brown	
 <p>Lever Surface Mount <i>Includes a V920 Closer</i></p>	Classic-View 360-16 360-48 360-79			#20298403	White	\$49.00
				#20298404	Brown	
 <p>White or Black Push-Button <i>Includes a V920 Closer</i></p>	Lifestyle 830-46	Value-Core 380-05	Life-Core 298-SS	#202878103	White	\$41.00
				#202878105	Black	
 <p>Modern Mortise Style Keyed <i>Secure Lock</i></p>	Lifestyle 2.0 370-84			#20281817	Brushed Nickel	\$75.00
 <p>Mortise Style Keyed <i>Secure Lock</i></p>	Lifestyle 691-90			#20275307	Brass	\$75.00
	Lifestyle 691-52			#20275317	Brushed Nickel	
	Lifestyle 691-55			#20275357	Aged Bronze	
 <p>Mortise Style <i>Secure Lock</i></p>	Lifestyle 830-80			#20275207	Brass	\$57.00
	Lifestyle 830-82			#20275217	Brushed Nickel	
	Lifestyle 830-85			#20275257	Aged Bronze	
 <p>Mortise Style Color-Match <i>Secure Lock</i></p>	Life-Core 278-SS 370-79 370-78			#20275203	White	\$49.00
				#20275204	Brown	
				#20275208	Almond	
				#20275209	Sandstone	

Parts & Accessories

Exterior/Interior Handleset Kits

HANDLESET	SERIES/MODEL	PART #	COLOR/FINISH	LIST PRICE	REKEYABLE OUTSIDE TRIM PLATE*			
Mortise Style Built-in Deadbolt <i>Includes QuickFit Handleset and Replacement Instructions.</i> 	Easy Vent Selection 146FVE (Fullview Low-E) 146FV (Fullview) 146BV (Decorative Bevel) 146MV (Midview) 146HV (Highview) 146PV (Pet Door)	Curved	#08716107	Brass	\$60.00	Optional to match Kwikset or Schlage entry door. <i>Rekeying to be performed by locksmith.*</i> 		
			#08716117	Brushed Nickel				
			#08716120	Antique Brass				
			#08716157	Aged Bronze				
			Straight	Elegant Selection 149PV (Pet Door) 149FVE (Fullview Low-E) 149FV (Fullview) 149BV (Decorative Bevel) 149EBV (Elegant Bevel)			#08719117	Brushed Nickel
							#08719157	Aged Bronze
	#08719153	Matte Black						
	Platinum Collection 456FV (Retractable Screen) 456FVE(Retractable Screen Low-E) 459FV (Interchangeable Screen) 459FVE (Interchangeable Screen Low-E) 450-18 (Secure Screen) 449-04 (Secure Glass)							
						List Price: \$40.00		

HANDLESET	SERIES/MODEL	PART #	COLOR/FINISH	LIST PRICE
	Classic-View 350-04	#08727207	Brass	\$75.00
	Classic-View 350-17	#08727217	Brushed Nickel	
	Lifestyle 356-60	#2026633	Brass	\$60.00
	Lifestyle 356-52	#2026683	Brushed Nickel	

Miscellaneous replacement parts call Larson at 1-800-334-1328.

*Does not include lock body. Not for use on doors made prior to 2015 or without QuickFit lock body. QuickFit Blank Key is not applicable for Schlage or Kwikset option locks.
 Note: Storm doors more than 3 years old may require hardware substitutions. Shipping and handling charges may apply. Requests to ship direct to a homeowner are subject to a shipping charge. Includes all products. Larson reserves the right to alter or discontinue any model, specification, warranty or price without notice. Product finish colors are approximate; actual finish colors may vary.



LARSON

larsondoors.com

1-888-483-3768

2333 Eastbrook Drive
Brookings, SD 57006



#larsondoors

Cover: Platinum 459 Interchangeable Full Glass, Black Frame with Straight Matte Black QuickFit Handleset
Back Cover: 370-84 Lifestyle 2.0 Midview Screen Away, White Frame

©2024 Larson Manufacturing Company, LLC. All rights reserved. LARSON and the Larson logo are trademarks of Larson Manufacturing Company, LLC. Registered trademarks are registered in the U.S. and may be registered internationally. Larson Manufacturing Company, LLC. is an operating company of Fortune Brands Innovations, Inc. All trademarks are property of their respective owners.

Part #0950950 HESB / FEB 2024